



PSI Services LLC

<https://test-takers.psiexams.com/ncbeec>

(855) 746-8173

## STATE OF NORTH CAROLINA



# BOARD OF ELECTRICAL CONTRACTORS EXAMINATION INFORMATION HANDBOOK

## CONTENTS

EXAMINATION PROCEDURE CHECKLIST .....	2
EXAMINATION CLASSIFICATIONS .....	3
REFERENCE MATERIALS .....	3
EXAMINATION SCHEDULING .....	4
Special Examination Arrangements (ADA) .....	4
Phone Registration .....	4
Online Registration .....	4
Cancelling and Rescheduling Exam .....	4
Missed Exam or Late Exam Cancellation .....	4
PSI Testing Site Closure .....	4
Social Security Number Confidentiality .....	4
PSI TESTING SITE LOCATIONS .....	5
REPORTING TO THE TESTING CENTER .....	5
Required Identification .....	5
Security Procedures .....	5
EXAMINATION BY COMPUTER .....	5
Taking the Examination .....	6
Examination Review .....	6
SCORE REPORTING .....	6
TIPS ON PREPARING .....	6
STUDY MATERIALS .....	7
EXAMINATION SUBJECT MATTER SCOPE .....	8
Subject Matter: Limited, Intermediate, Unlimited, Single-Family & Fire Alarm Low-Voltage Examinations .....	8
Subject Matter: Special Restricted Examinations .....	10
SAMPLE EXAMINATION QUESTIONS .....	12
PRACTICE QUESTIONS .....	14
Limited, Intermediate, and Unlimited Questions .....	14
Special Restricted Practice Questions .....	19
ANSWER KEY FOR PRACTICE QUESTIONS .....	22
<b>NC ELECTRICAL CONTRACTORS LICENSING LAW: G.S. CHAPTER 87-44 .....</b>	<b>23</b>
<b>NCBEEC BOARD RULES: TITLE 21-18 .....</b>	<b>30</b>
OTHER ELECTRICAL CONTRACTOR RELATED LAWS .....	50
CHAPTER 66 - ARTICLE 4 .....	50
CHAPTER 160D – ARTICLE 11 .....	51
CHAPTER 93B-15.1 .....	59
CHAPTER 143-138 (B16) .....	60
EXAMINATION APPLICATION CHECKLIST .....	61
APPLICATION FOR EXAMINATION .....	62
EMPLOYER STATEMENT FORMS .....	63
CHARACTER STATEMENT FORMS .....	64
SUPERVISE & DIRECT STATEMENT FORMS .....	66
LIGHTING & POWER PLANS .....	68

## BOARD MEMBERS

---

Chairman

DAN POST

Vice Chairman

JOSEPH STARLING

Members

JAMES BUCHANAN

STUART LANEY

KEVIN TICE

JEFF TRACY

DR. CHRIS HORNE

---

## BOARD STAFF MEMBERS

---

TIM NORMAN, Executive Director

AL PARRIS, Enforcement Manager

MORGAN KING, Office Manager

MICHAEL BIRR, Field Investigator

MATT CHAMBERS, Field Investigator

HAL LITTLE, Field Investigator

CHANCE SOURIYAVONG, Administrative Assistant

TONYA LYNCH, Administrative Assistant

TBD, Administrative Assistant

**NCBEEC**  
**505 N. Greenfield Pkwy, Suite 100**  
**Garner, NC 27529**

Email: [office@ncbeec.org](mailto:office@ncbeec.org)

Phone: (919) 733-9042

Fax: (800) 691-8399

[www.ncbeec.org](http://www.ncbeec.org)

**July 2023**

## EXAMINATION PROCEDURE CHECKLIST

**Before registering for an examination, make sure that you have reviewed the checklist below.**

- You must get approval from the Board to take an examination.
- Complete the *Examination Application Form* (found at the end of this book) and return it to the Board's office with the examination fee and other documents as detailed on the instruction page of the application.
- Upon approval you will receive a *Notice of Approval* letter from the Board.
- Your Notice of Approval will list:
  - Your ID number (necessary to register with PSI for your examination).
  - Your authorization period to schedule and sit for your examination. You will have 90 days from the date of approval to take your exam.
- Your approval includes only **ONE (1)** examination attempt. Should you fail the examination, you must re-apply to the Board for a new approval.
- Should you miss your 90-day examination authorization window, you must re-apply for examination and resubmit with fee to the Board.

### Schedule Your Examination:

- Register online at <https://test-takers.psiexams.com/ncbeec>, or call (855) 746-8173 to register.
- Refer to your Notice of Approval for the ID number required to register for your examination with PSI.

### Take Your Examination:

- Must bring two forms of valid (non-expired) identification, which bear your signature. One of these must also have your photograph.
- Your name as shown on the state approved roster must exactly match the name on the photo I.D. used when checking in at the examination site.
- Bring your own reference materials: 2020 National Electrical Code and 2013 edition of the National Fire Alarm Code 72. Reference materials will not be supplied to you.
- Arrive 30 minutes prior to appointment.

### After Your Examination:

- You will receive your results at your chosen PSI testing center upon completion of the examination.
- Upon completion of the examination your results will be sent electronically to the Board.
- You must complete a License Application to obtain and activate a license. For licensing information visit [www.ncbeec.org](http://www.ncbeec.org).

### Retest Rules:

- A person who fails an examination will not be eligible to take another examination in the same classification until 3 months after the date of the failed examination.
- You will have the opportunity to review your failed examination once. Further details regarding reviews can be found on page 5.
- If you do not receive an Examination Review Request form from your PSI testing center after completing your exam, or if you would like more information, visit our website at [www.ncbeec.org](http://www.ncbeec.org) and download the form from our Forms & Documents page.

**Be sure you understand the contents of this handbook  
before applying for your examination.**

**Please retain and use it as a reference when contacting PSI.**

## INTRODUCTION

The Board develops its own licensing examinations and determines the scores that applicants must achieve to pass them. However, the Board has contracted with PSI, a national testing company that provides a variety of licensing and certification services to regulatory agencies, to administer and score the licensing examinations. Although the Board has delegated certain examination administration functions to PSI, the Board itself remains responsible for the quality of its examination programs.

This Examination Information Handbook is furnished by the North Carolina State Board of Examiners of Electrical Contractors (NCBEEC, henceforth referred to as the "Board") to each candidate interested in applying to take the examination for a North Carolina electrical contracting license in the Limited, Intermediate, or Unlimited classification, or in any of the Special Restricted classifications.

**This Examination Information Handbook contains all required forms**, as well as the *Electrical Contractors Licensing Law* (General Statutes Chapter 87, Article 4) and the *Board's Rules* (Title 21, North Carolina Administrative Code, Chapter 18B) for the implementation of these laws along with other pertinent laws applicable to electrical contractors. Also included are the *Lighting and Power Plans* that will be referenced in the examinations.

## EXAMINATION CLASSIFICATIONS

### Limited, Intermediate, Unlimited Examinations

The examination for an electrical contracting license in the Limited, Intermediate, and Unlimited classifications consists of one hundred (100) multiple-choice questions. You will have a maximum time of six (6) hours to complete the examination.

### Special Restricted Examinations: Single Family Detached Residential Dwelling (SP-SFD), Plumbing and Heating (SP-PH), Electric Sign (SP-ES), Elevator (SP-EL), Groundwater Pump (SP-WP)

The examination for an electrical contracting license in any of the Special Restricted classifications (excluding Fire Alarm/Low Voltage and Swimming Pool Bonding) consists of forty (40) multiple-choice questions. You will have a maximum time of three (3) hours to complete the examination.

### Special Restricted Examination: Fire Alarm/Low Voltage (FA/LV)

The examination for an electrical contracting license in the Special Restricted Fire Alarm/Low Voltage (FA/LV) classification consists of fifty (50) multiple-choice questions. You will have a maximum time of three (3) hours to complete the examination.

### Special Restricted Examination: Swimming Pool Bonding (SP-SP)

The examination for an electrical contracting license in the Special Restricted Swimming Pool Bonding (SP-SP) classification consists of twenty-five (25) multiple-choice questions. You will have a maximum time of one (1) hour to complete this examination.

## REFERENCE MATERIALS

**The examinations are OPEN BOOK. Each candidate is required to bring their own copy of the 2020 National Electrical Code.** Candidates taking an examination in the Limited, Intermediate, Unlimited, SP-SFD or SP-FA/LV classifications are also required to bring a copy of the 2013 edition of the National Fire Alarm Code. The references listed above are the **ONLY** references allowed in the examination center. **Candidates are responsible for bringing their own references to the examination center.**

References shall be softbound, spiral, or hardbound. Loose leaf references are not allowed. Reference materials may be highlighted, underlined, and/or annotated prior to the examination session. Notes on the pages of the reference materials are allowed. However, if notes are written in pencil, they MUST be highlighted; if written in pen, they DO NOT need to be highlighted. NO partial references will be allowed as acceptable reference materials for exams.

References may not be written in during the examination session. Any candidate caught writing in the references during the examination will have the references confiscated and will be reported to the Board. Furthermore, candidates are not permitted to bring in any additional papers (loose or attached) within their approved references. Any additional materials will be removed from the references and confiscated.

References may be tabbed with permanent tabs only. Temporary tabs, such as post-it notes or stapled tabs, are not allowed and must be removed from the reference before the exam begins. Likewise, divider tabs are not allowed.

Writing in the references, bringing unpermitted additional papers into the test center, or presence of improper tabs, shall be considered evidence of cheating and grounds for invalidation of the exam, disqualification for future exams, and discipline.

### Reference Materials to Bring to Testing Center:

1. The National Electrical Code, 2020 edition.
2. National Fire Alarm Code, 2013 edition (*Limited, Intermediate, Unlimited, SP -SFD and SP -FA/LV only*).

Calculators, scratch paper and pencils will be provided at the test center. Only the references listed above will be allowed in the testing center; no other books or reference materials are permitted.

In addition to the 2020 NEC and 2013 NFPA (if applicable), the examination will consist of questions concerning the following references:

1. Electrical Contractors Licensing Law (*General Statutes Chapter 87, Article 4*)
2. The Board's Rules for the Implementation of the Electrical Contractors Licensing Law (*Title 21, North Carolina Administrative Code, Chapter 18B*)
3. NASCLA Contractors' Guide to Business, Law, and Project Management: North Carolina Electrical Edition.

These references are "CLOSED BOOK" questions. That is, no candidate will be allowed to refer to any part of these documents during the examination.

## EXAMINATION SCHEDULING

After you carefully study this Examination Information Handbook and select the classification of license you desire and for which you feel qualified to be examined:

1. Complete the *Examination Application Form* (found at the end of this book) and return it to the Board's office with the required examination fee and other required information as detailed on the instruction page of the application.
2. If approved by the Board, your application will be processed and you will receive a *Notice of Approval* letter.
3. Refer to your *Notice of Approval* for the ID number required to register for your examination with PSI and your authorization period dates.
4. Register via phone by calling PSI at (855) 746-8173 OR you may register online through PSI by visiting <https://test-takers.psiexams.com/ncbeec>. (You can only register for your approved exam within your 90-day authorization period.)

Your authorization includes only 1 examination attempt. Should you fail the examination, you must re-apply for examination with the Board to receive a new approval and authorization.

A candidate who fails an examination shall not be eligible to take another examination in the same classification until 3 months after the date of the failed examination. Should you miss your examination or fail to register for your examination within your 90-day authorization period, you must re-apply to take the examination and submit with fee to the Board.

You will have the opportunity to review your failed examination once. You will receive an *Examination Review Request Form* upon completion of the failed examination at the PSI testing center. If you do not receive an *Examination Review Request Form* from PSI and you would like to review your exam, visit our website at [www.ncbeec.org](http://www.ncbeec.org) and download the *Exam Review Request Form* from our Forms & Documents page.

The fee for your examination is included in the payment made to the Board along with your submission of the *Examination Application Form*. There are no additional fees.

### SPECIAL EXAMINATION ARRANGEMENTS (ADA)

All examination centers are equipped to provide access in accordance with the Americans with Disabilities Act (ADA) of 1990, and every reasonable accommodation will be made in meeting a candidate's needs.

Applicants with disabilities or those who would otherwise have difficulty taking the examination must contact the Board. **You must be approved by the Board for special accommodations prior to PSI making the appropriate accommodations.** Therefore, it is best to first get approval for special accommodation from the Board before contacting PSI for an examination date and time.

### PHONE REGISTRATION

PSI registrars are available at (855) 746-8173 to schedule your appointment for the examination. Registrars are available: Monday –

Friday, 7:30 am - 10:00 pm (eastern) and Saturday – Sunday, 9:00 am - 5:30 pm (eastern).

### ONLINE REGISTRATION

For the fastest and most convenient examination scheduling process, PSI recommends that you register for your examinations using the Internet. You register online by accessing PSI's registration website at <https://test-takers.psiexams.com/ncbeec>. Internet registration is available 24 hours a day.

Log onto PSI's website and select Sign in / Create Account. Select Create Account. You are now ready to schedule the exam. Enter your zip code and a list of the testing sites closest to you will appear. Once you select the desired test site, available dates will appear.

### CANCELLING AND RESCHEDULING EXAM

You may cancel and reschedule an examination appointment without losing your fee if your cancellation notice is received 2 days before the scheduled examination date. For example, for a Monday appointment, the cancellation notice would need to be received on the previous Saturday. Reschedule with PSI online by visiting <https://test-takers.psiexams.com/ncbeec> or call (855) 746-8173.

NOTE: A voice mail message is not an acceptable form of cancellation. Please use the PSI Website or call PSI to speak directly to a Customer Service Representative.

### MISSED EXAM OR LATE EXAM CANCELLATION

If you miss your exam appointment, you lose your examination fee. Further, you will lose your examination fee if you:

- Do not cancel your appointment more than 2 days before the scheduled examination date.
- Do not appear for your examination appointment.
- Arrive after examination start time.
- Do not present proper identification when you arrive for the examination.
- Are found writing in your references during your examination.
- Are found with unpermitted additional references and/or materials in the test center.

### PSI TESTING SITE CLOSURE

In the event that severe weather or another emergency forces the closure of an examination site on a scheduled examination date, your examination will be rescheduled. PSI personnel will attempt to contact you in this situation. However, you may check the status of your examination schedule by calling (855) 746-8173. Every effort will be made to reschedule your examination at a convenient time as soon as possible. You will not be penalized. You will be rescheduled at no additional charge.

### SOCIAL SECURITY NUMBER CONFIDENTIALITY

PSI will use your social security number only as an identification number in maintaining your records and reporting your examination results to the Board. A Federal law requires State agencies to collect and record the social security numbers of all licensees of the professions licensed by the Board.



## PSI TESTING SITE LOCATIONS

### ASHEVILLE

1306 C Patton Avenue  
Asheville, NC 28806

### CHARLOTTE

Tyvola Executive Park 1  
5701 Westpark Dr, #202  
Charlotte, NC 28217

### GREENVILLE

Charles Center  
2404 South Charles Blvd.  
Suite B  
Greenville, NC 27858

### RALEIGH

5711 Six Forks Road  
Suite 208  
Raleigh, NC 27609

### FAYETTEVILLE

3724 Sycamore Dairy Road  
Suite 128  
Arbor Alley Building  
Fayetteville, NC 28303

### WILMINGTON

Judges Road Business Park  
311 Judge's Road  
Suite 8D  
Wilmington, NC 28405

### WINSTON-SALEM

1540 Westbrook Plaza Drive  
Suite 103  
Winston-Salem, NC 27103

## REPORTING TO THE TESTING CENTER

On the day of your examination, you should arrive 30 minutes before your appointment. This extra time is for sign-in, identification, and familiarizing you with the examination process. ***If you arrive late, you may not be admitted to the examination site and you will lose your examination registration fee.***

### REQUIRED IDENTIFICATION

Candidates must register for the exam with their LEGAL first and last name as it appears on their government issued identification. All

required identification below must match the first and last name under which the candidate is registered.

Candidates are required to bring two (2) forms of valid (non-expired) signature bearing identification to the test site. If you do not bring proper identification or the candidate names do not match, you will not be allowed to test and your examination fee will not be refunded.

### PRIMARY IDENTIFICATION

- State issued driver's license
- State issued identification card
- US Government Issued Passport
- US Government Issued Military Identification Card
- US Government Issued Alien Registration Card

### SECONDARY IDENTIFICATION

- Credit Card (must be signed)
- Social Security Card
- US issued Birth Certificate with Raised Seal

\*NOTE: Student ID and employment ID are **NOT** acceptable forms of identification.

## SECURITY PROCEDURES

The following security procedures apply during examinations:

- No children, notes, briefcases, backpacks, hats, cellular telephones, or pagers are allowed in the examination area. (Note: There is no space to store these materials at the examination center.) Small purses (size of a wallet) will be permitted. Larger purses cannot be taken to the candidate's seat.
- No smoking, eating, or drinking is allowed in the examination center.
- Once you have been seated and the examination begins, you may leave the examination center only to use the restroom, and only after obtaining permission from the proctor. You will not receive extra time to complete the examination.
- Anyone seen giving or receiving assistance, found with unauthorized materials, or who violates any security regulations will be asked to surrender all examination materials and to leave the examination center. All such instances will be reported to the Board.
- Copying or communicating examination content is a violation of security regulations and may result in the cancellation of your examination results or legal action taken under copyright laws.

## EXAMINATION BY COMPUTER

You do not need any computer experience or typing skills when taking the examination on the computer. All response keys are colored and have prominent characters. You may also use the mouse.

### IDENTIFICATION SCREEN

You will be directed to a semiprivate testing station to take the examination. When you are seated at the testing station, you will be prompted to confirm your name, identification number, and the examination for which you are registered.

### TESTING TUTORIAL

Before you start your examination, an introductory tutorial to the computer and keyboard is provided on the computer. The time you



spend on this tutorial, up to 15-minutes, DOES NOT count as part of your examination time. Sample questions are included following the tutorial so that you may practice using the keys, answering questions, and reviewing your answers.

## TAKING THE EXAMINATION

One question appears on the screen at a time. During the examination, the minutes remaining will be displayed at the top of the screen and updated as you record your answers.

The “Function Bar” at the top of the screen provides mouse-click access to the features available on the examination. These are also available by using the labeled keys on the keyboard.

**IMPORTANT:** After you have entered your responses, you will later be able to return to any question(s) and change your response, provided the examination time has not run out.

Upon completion of your examination, you will immediately receive your Score Report. The passing Score Report will instruct you to contact the Board for your licensing options. A failed score report will be accompanied by an *Examination Review Request Form*. All candidate examination results are sent to the Boards information system to remain on file indefinitely.

*NOTE: Until you have qualified by passing the examination and have obtained a license from the Board, it is unlawful for you to engage or offer to engage in the business of electrical contracting in the State of North Carolina as defined in North Carolina General Statute 87-43.*

## EXAMINATION REVIEW

Within the 12-months immediately following your exam, you may review your failed examination once. You are encouraged to review your failed examination BEFORE taking another examination.

The Board provides group review sessions with an opportunity to ask questions and receive assistance. Reviews are held at the Board’s office in group sessions lasting approximately 4-hours. The review sessions are scheduled monthly throughout the year. You may request an individual examination review if you are unable to attend a group review session.

To register for an exam review, complete the *Examination Review Request Form* given to you by PSI at the testing center OR download the *Exam Review Form* from our website at [www.ncbeec.org](http://www.ncbeec.org) on the Forms & Documents page. Submit your review request form to the Board’s office with the required review fee.

After submitting a review request form, Board staff will send you a review notice containing the details of your exam review session.

## SCORE REPORTING

The Board has set its passing score for each examination to represent a minimally acceptable level of performance. Passing scores are determined by procedures that identify a level of examination performance that the Board believes necessary if licensees are to practice safely and effectively.

Currently, the passing score for all examinations is 70%. This means that you must correctly answer at least 70% of all questions on the examination you take in order to pass.

Your score will be given to you immediately following completion of the examination. Your score will appear immediately on the computer screen; this will happen automatically at the end of the time allowed for the examination.

- If you pass, you will immediately receive a successful notification.
- If you do not pass, you will receive a diagnostic report indicating your strengths and weaknesses by examination type with the score report.

You will also receive an unofficial score report printed at the examination site. The passing Score Report will instruct you to contact the Board for your licensing options or visit our website at [www.ncbeec.org](http://www.ncbeec.org) and see the Licensing page. You may request a duplicate score report after your examination by contacting PSI.

## TIPS ON PREPARING

The following suggestions will help you prepare for your examination:

1. Only consider the actual information given in the question, do not “read into” the question or consider outside information or other possibilities.
2. Read this handbook in its entirety, cover to cover.
3. Use the examination content outline as the basis of your study.
4. Read and review all of the reference materials listed at the beginning of this handbook under *Reference Materials*; these items cover all the topics in the content outline.
5. Take notes on what you study. Putting information in writing helps you commit it to memory.
6. Discuss new terms or concepts as frequently as you can with colleagues. This will test your understanding and reinforce ideas.
7. Your studies will be most effective if you study frequently, for periods of approximately 45-60 minutes per day.
8. Study an illustrated guide for exam preparation book (you can search for this online). Many books are available that show illustrations associated with difficult to understand concepts, calculations, grounding, and bonding etc.
9. Practice calculations (the more experience you gain, the easier they will be when taking the exam).
10. Consider attending a Board approved continuing-education course. There are many approved continuing-education courses available that review the NEC and its major concepts. To find a course, use the *CE Class Search* function on our homepage at [www.ncbeec.org](http://www.ncbeec.org).

## FRACTIONS OF AN AMPERE

Except where the computations result in a major fraction of an ampere (.5 or larger), such fractions may be dropped.

### EXAMPLES:

- 99.5 amperes = 100 amperes (.5 is a major fraction, therefore you rounded upward)
- 99.4 amperes = 99 amperes (.4 is not a major fraction, therefore you dropped the fraction and rounded downward)

### Exceptions to Standard Procedures

In certain areas the NEC stipulates a standard procedure that should be followed in normal circumstances but permits alternative procedure(s) or exception(s) in some circumstances. IF THE QUESTION DOES NOT SPECIFICALLY EXCLUDE THE ALTERNATIVE PROCEDURE(S) OR EXCEPTION(S) PERMITTED BY THE NEC, THE EXAMINEE SHOULD APPLY THESE PROVISIONS OF THE NEC.

## STUDY MATERIALS

The exam candidate should study the following materials in preparing for the examination:

1. **National Electrical Code, 2020 Edition**
  - Purchase from the National Fire Protection Association (NFPA) at <https://catalog.nfpa.org>.
2. **Laws Applicable to Electrical Contractors in North Carolina (General Statutes, Chapter 87, Article 4) and the Board's Rules (Title 21, NCAC, Chapter 18B)**
  - Both are already included in this information handbook or can be downloaded from our website at [www.ncbeec.org](http://www.ncbeec.org).
3. **Lighting and Power Plans**
  - Required for the Limited, Intermediate, and Unlimited classifications only.
  - Plans are included at the back of this handbook.
4. **NASCLA Contractors Guide to Business, Law and Project Management: North Carolina Electrical Contractors' Edition.**
  - Purchase from the NASCLA online bookstore at [www.nascla.org/store/](http://www.nascla.org/store/).
5. **National Fire Alarm Code, 2013 Edition**
  - Required for the Limited, Intermediate, Unlimited, SP-SFD and SP-FA/LV classifications only.
  - Purchase from the National Fire Protection Association (NFPA) at <https://catalog.nfpa.org>.



## EXAMINATION SUBJECT MATTER SCOPE

Each examination question is designed to test one particular point of the subject matter. The wording is straightforward and there is no intent to mislead or present “trick” questions. A question may be phrased so that some of the aspects of the point being tested have been left out.

Each question has only one (1) correct answer, although some answers may be partially correct. Read each question and answer thoroughly and then select the answer that appears to be the most correct answer to the question.

The approximate subject matter covered in each of the ten (10) electrical contracting license examinations is shown in the following *Scope of Subject Matter for Electrical Contracting License Examinations* table. Applicants for the INTERMEDIATE and UNLIMITED examinations should note the increased areas of coverage for those respective examinations and that the difficulty level of the questions in their examinations will be higher.

**Note:** For each of the ten (10) classifications, an asterisk (\*) listed beside a topic indicates that the topic will be covered on the examination. A hyphen (-) indicates that the topic will not be covered on the examination.

<b>Subject Matter: Limited, Intermediate, Unlimited, Single-Family &amp; Fire</b>	<b>LIM</b>	<b>INT</b>	<b>UNL</b>	<b>SP-SFD</b>	<b>SP-FA/LV</b>
<b>Alarm Low-Voltage Examinations</b>					
<b>1. BONDING AND GROUNDING</b>					
a. Systems and equipment requiring grounding and ground-fault protection	*	*	*	*	*
b. Location of connection and required interconnections	*	*	*	*	*
c. Grounded, grounding, and grounding electrode conductors					
(1) Conductor identification and color coding	*	*	*	*	*
(2) Sizing					
(a) Bonding jumpers	*	*	*	*	*
(b) Grounding electrode conductors	*	*	*	*	-
(c) Equipment grounding conductors	*	*	*	*	*
(d) Grounding electrodes	*	*	*	*	-
d. Methods of grounding and bonding, equipment, and conductor specifications					
(1) Low-voltage specifications	*	*	*	*	*
(2) High-voltage specifications	-	*	*	-	-
e. Bonding conductor connections	*	*	*	*	*
f. Bonding/bonding grid	*	*	*	*	-
g. Termination	*	*	*	*	*
APPROXIMATE NUMBER OF QUESTIONS	10	11	11	5	4
<b>2. OVERCURRENT PROTECTION</b>					
a. Location in circuit	*	*	*	*	-
b. Sizing requirements	*	*	*	*	-
c. Circuit breakers	*	*	*	*	-
d. Plug and cartridge fuses	*	*	*	*	-
e. Enclosures and locations	*	*	*	*	-
f. High-voltage	-	*	*	-	-
APPROXIMATE NUMBER OF QUESTIONS	9	9	9	4	0
<b>3. WIRING METHODS AND TERMINATIONS</b>					
a. Raceway systems					
(1) Permitted applications and usages	*	*	*	*	*
(2) Characteristics	*	*	*	*	*
(3) Conduit and wireway fill	*	*	*	*	*
b. Cable systems					
(1) Permitted applications and usages	*	*	*	*	*
(2) Characteristics	*	*	*	*	*
(3) Protection from damage	*	*	*	*	*
(4) Traveling cables and controls	-	*	*	-	*
c. Conductors					
(1) Permitted usages and ampacity ratings	*	*	*	*	*
(2) Characteristics	*	*	*	*	*
(3) Miscellaneous	*	*	*	*	*
(4) Outdoors	*	*	*	*	*
d. Switchboards, panelboards, switches, and cabinets	*	*	*	*	-
e. Special conditions	*	*	*	*	-
f. High-voltage	-	*	*	-	-
APPROXIMATE NUMBER OF QUESTIONS	10	10	10	3	9

SUBJECT MATTER FOR ELECTRICAL CONTRACTING LICENSE EXAMINATIONS	LIM	INT	UNL	SP-SFD	SP-FA/LV
4. BOXES AND FITTINGS					
a. General information	*	*	*	*	*
b. Sizing requirements	*	*	*	*	*
APPROXIMATE NUMBER OF QUESTIONS	8	7	7	4	3
5. SERVICE ENTRANCE AND EQUIPMENT					
a. Installation requirements	*	*	*	*	-
b. Service equipment	*	*	*	*	-
c. General sizing requirements	*	*	*	*	-
APPROXIMATE NUMBER OF QUESTIONS	11	9	9	4	0
6. MOTORS AND CONTROL WIRING					
a. General information	*	*	*	*	*
b. Branch circuit and feeder ampacity	*	*	*	*	-
c. Overload protection	*	*	*	*	-
d. Short-circuit and ground-fault protection	*	*	*	*	-
e. Disconnects/controllers	*	*	*	*	-
(1) Size	*	*	*	*	-
(2) Type	*	*	*	*	-
(3) Location	*	*	*	*	-
f. Separation of conductors	*	*	*	*	*
APPROXIMATE NUMBER OF QUESTIONS	7	8	9	2	3
7. SPECIAL OCCUPANCIES AND HAZARDOUS LOCATIONS					
a. Special occupancies					
(1) Emergency systems	-	*	*	-	-
(2) Health care facilities	-	*	*	-	-
(3) Mobile homes and mobile home parks	*	*	*	*	-
(4) Places of assembly, theaters, and similar locations	-	*	*	-	-
(5) Swimming pools	*	*	*	*	-
(a) Underwater lighting fixtures	*	*	*	*	-
b. Hazardous locations					
(1) General requirements	-	*	*	-	-
(2) Specific requirements					
(a) Aircraft hangars	-	-	*	-	-
(b) Bulk storage plants	-	*	*	-	-
(c) Finishing processes	-	*	*	-	-
(d) Gas stations and commercial garages	-	*	*	-	-
APPROXIMATE NUMBER OF QUESTIONS	6	9	9	1	0
8. LOAD CALCULATIONS					
a. Branch circuits	*	*	*	*	-
b. Total computed load	*	*	*	*	-
c. Conductor ampacity requirements	*	*	*	*	*
d. Overcurrent protective device sizing					
(1) Low-voltage	*	*	*	*	*
(2) High-voltage	-	*	*	-	-
APPROXIMATE NUMBER OF QUESTIONS	11	11	11	4	4
9. APPLIANCES, EQUIPMENT, AND LIGHTING					
a. Air conditioners	*	*	*	*	-
b. Residential, commercial, and industrial equipment	*	*	*	*	-
c. Lighting fixtures	*	*	*	*	-
d. Space heating equipment and boilers	*	*	*	*	-
e. Transformers	*	*	*	*	-
f. Machine room	-	*	*	-	-
APPROXIMATE NUMBER OF QUESTIONS	7	7	7	3	0
10. GENERAL					
a. Definitions	*	*	*	*	*
b. Installation requirements	*	*	*	*	*
APPROXIMATE NUMBER OF QUESTIONS	3	3	3	2	6

SUBJECT MATTER FOR ELECTRICAL CONTRACTING LICENSE EXAMINATIONS	LIM	INT	UNL	SP-SFD	SP-FA/LV
11. LAWS, RULES, BASIC BUSINESS PRACTICES, AND PRACTICAL APPLICATIONS					
a. Electrical Contractors Licensing Law (General Statutes Chapter 87, Article 4)	*	*	*	*	*
b. Board's Rules for the Implementation of the Electrical Contractors Licensing Law (Title 21, North Carolina Administrative Code, Chapter 18B)	*	*	*	*	*
c. NASCLA Contractors' Guide to Business, Law and Project Management - North Carolina Electrical Edition	*	*	*	*	*
d. Lighting and Power Plans; Estimating and General Knowledge	*	*	*	-	-
e. National Fire Alarm Code	*	*	*	*	*
APPROXIMATE NUMBER OF QUESTIONS	18	16	15	8	21
<b>TOTAL NUMBER OF QUESTIONS</b>	<b>100</b>	<b>100</b>	<b>100</b>	<b>40</b>	<b>50</b>
<b>Subject Matter: Special Restricted Examinations</b>	<b>SP-PH</b>	<b>SP-ES</b>	<b>SP-EL</b>	<b>SP-WP</b>	<b>SP-SP</b>
1. BONDING AND GROUNDING					
a. Systems and equipment requiring grounding and ground-fault protection	*	*	*	*	*
b. Location of connection and required interconnections	*	*	*	*	*
c. Grounded, grounding, and grounding electrode conductors	*	*	*	*	-
(1) Conductor identification and color coding	*	*	*	*	-
(2) Sizing					
(a) Bonding jumpers	*	*	*	*	*
(b) Equipment grounding conductors	*	*	*	*	*
d. Methods of grounding and bonding, equipment and conductor specifications	*	*	*	*	*
(1) Low-voltage specifications	*	*	*	-	-
e. Bonding conductor connections	*	*	*	*	*
f. Bonding/bonding grid	*	-	*	-	*
g. Termination	*	*	*	*	*
APPROXIMATE NUMBER OF QUESTIONS	4	5	5	7	7
2. OVERCURRENT PROTECTION					
a. Location in circuit	*	*	*	*	-
b. Sizing requirements	*	*	*	*	-
c. Circuit breakers	*	*	*	*	-
d. Plug and cartridge fuses	*	*	*	*	-
e. Enclosures and locations	*	*	*	-	-
APPROXIMATE NUMBER OF QUESTIONS	5	4	4	3	0
3. WIRING METHODS AND TERMINATIONS					
a. Raceway systems					
(1) Permitted applications and usages	*	*	*	*	-
(2) Characteristics	*	-	*	*	-
(3) Conduit and wireway fill	*	*	*	-	-
b. Cable systems					
(1) Permitted applications and usages	*	*	*	*	-
(2) Characteristics	*	*	*	*	-
(3) Protection from damage	*	*	*	*	-
(4) Traveling cables and controls	-	-	*	-	-
c. Conductors					
(1) Permitted usages and ampacity ratings	*	*	*	*	-
(2) Characteristics	*	*	*	*	-
(3) Miscellaneous	*	-	-	*	-
(4) Outdoors	-	*	-	*	-
d. Switchboards, panelboards, switches, and cabinets	-	-	*	-	-
APPROXIMATE NUMBER OF QUESTIONS	8	8	10	9	0
4. BOXES AND FITTINGS					
a. General information	*	*	*	*	*
b. Sizing requirements	*	*	*	*	*
APPROXIMATE NUMBER OF QUESTIONS	2	2	2	3	3
5. SERVICE ENTRANCE AND EQUIPMENT					
a. Installation requirements	-	-	-	-	-
b. Service equipment	-	-	-	-	-
c. General sizing requirements	-	-	-	-	-
APPROXIMATE NUMBER OF QUESTIONS	0	0	0	0	0



SUBJECT MATTER FOR SPECIAL RESTRICTED ELECTRICAL CONTRACTING LICENSE EXAMINATIONS	SP- PH	SP- ES	SP- EL	SP- WP	SP- SP
<b>6. MOTORS AND CONTROL WIRING</b>					
a. General information	*	-	*	*	-
b. Branch circuit and feeder ampacity	*	-	*	*	-
c. Overload protection	*	-	*	*	-
d. Short-circuit and ground-fault protection	*	-	*	*	-
e. Disconnects/controllers	*	-	-	*	-
(1) Size	*	-	*	-	-
(2) Type	*	-	-	*	-
(3) Location	*	-	*	*	-
f. Separation of conductors	*	-	*	*	-
APPROXIMATE NUMBER OF QUESTIONS	5	0	5	5	0
<b>7. SPECIAL OCCUPANCIES AND HAZARDOUS LOCATIONS</b>					
a. Swimming pools	-	-	-	-	*
(1) Underwater lighting fixtures	-	-	-	-	*
(2) Underwater audio equipment	-	-	-	-	*
(3) Forming shells	-	-	-	-	*
APPROXIMATE NUMBER OF QUESTIONS	0	0	0	0	10
<b>8. LOAD CALCULATIONS</b>					
a. Branch circuits	*	-	*	*	-
b. Total computed load	*	-	-	*	-
c. Conductor ampacity requirements	*	*	*	*	-
d. Overcurrent protective device sizing	*	*	*	*	-
(1) Low-voltage	*	-	*	*	-
APPROXIMATE NUMBER OF QUESTIONS	2	3	3	3	0
<b>9. APPLIANCES, EQUIPMENT, AND LIGHTING</b>					
a. Air conditioners	*	-	-	-	-
b. Residential, commercial, and industrial equipment	*	-	-	-	-
c. Space heating equipment and boilers	*	-	-	-	-
d. Transformers	-	*	-	-	-
APPROXIMATE NUMBER OF QUESTIONS	4	4	0	0	0
<b>10. GENERAL</b>					
a. Definitions	*	*	*	*	-
b. Installation requirements	*	*	*	*	-
APPROXIMATE NUMBER OF QUESTIONS	3	7	2	2	0
<b>11. LAWS, RULES, BASIC BUSINESS PRACTICES, AND PRACTICAL APPLICATIONS</b>					
a. Electrical Contractors Licensing Law (General Statutes Chapter 87, Article 4)	*	*	*	*	*
b. Board's Rules for the Implementation of the Electrical Contractors Licensing Law (Title 21, North Carolina Administrative Code, Chapter 18B)	*	*	*	*	*
c. NASCLA Contractors' Guide to Business, Law and Project Management -North Carolina Electrical Edition	*	*	*	*	*
d. Lighting and Power Plans; Estimating and General Knowledge	*	-	-	-	-
e. National Fire Alarm Code	-	-	-	-	-
APPROXIMATE NUMBER OF QUESTIONS	7	7	9	8	5
<b>TOTAL NUMBER OF QUESTIONS</b>	<b>40</b>	<b>40</b>	<b>40</b>	<b>40</b>	<b>25</b>

## SAMPLE EXAMINATION QUESTIONS

The examples beginning on this page are intended to illustrate the type of questions that appear on the **LIMITED, INTERMEDIATE, and UNLIMITED** examinations. The examples can be considered typical examination questions, but these specific questions will not appear on any of the examinations.

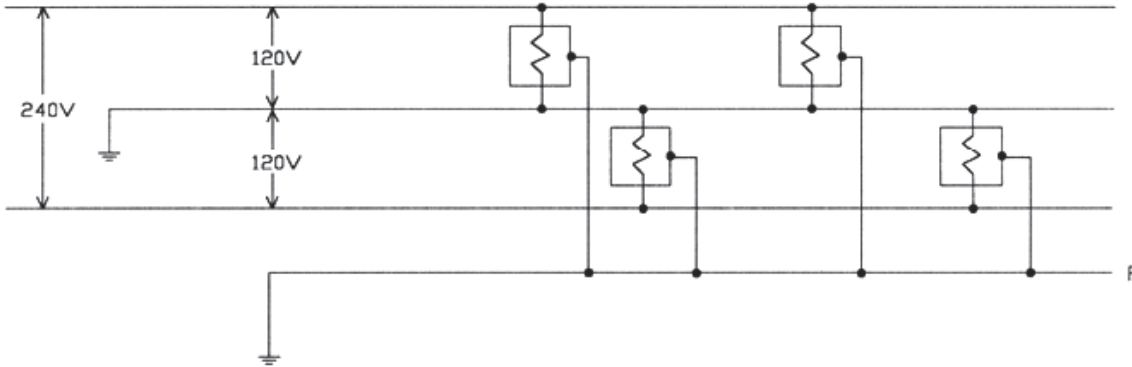

**EXAMPLE 1:**

In the diagram shown above: Disregarding all exceptions. Conductor “P” shall be identified by which of the following colors?

- (A) Gray
- (B) White
- (C) Black
- (D) Green



Here you are asked to select from the listed colors the one that is to be used to identify the equipment grounding conductor of a branch circuit. Since Section 250.119 of the NEC requires that green or green with yellow stripes be the color of insulation used on a grounding conductor (when it is not bare), the correct answer is **(D)**.

**EXAMPLE 2:**

A circuit leading to a gasoline dispensing pump must have a disconnecting means:

- (A) Only in the grounded conductor.
- (B) Only in the ungrounded conductors.
- (C) Operating independently in all conductors.
- (D) Operating simultaneously in all conductors.



Here the “question” is in the form of an incomplete statement. Your task is to select the choice that best completes the statement. In this case, you should have selected **(D)** since section 514.11(A) of the NEC specifies that such a circuit shall be provided with a means to disconnect simultaneously from the source of supply all conductors of the circuit, including the grounded conductor, if any.

**EXAMPLE 3:**

In existing branch-circuit installations, the grounded conductor of the dryer circuit shall be connected to the equipment grounding conductor of an electric clothes dryer and all of the following conditions must be met **EXCEPT**:

- (A) The grounded conductor is not smaller than size 10 AWG copper or size 8 AWG aluminum.
- (B) The grounding contacts of the receptacle installed with the dryer are bonded to the dryer.
- (C) The supply circuit is a 120/240V, 1Ø, 3-wire circuit derived from a 3Ø, 4-wire delta system.
- (D) The grounded conductor is insulated, or if uninsulated and part of a Type SE service-entrance cable, and the branch circuit originates at the service equipment.



Again the “question” is in the form of an incomplete statement and your task is to select the choice that best completes the statement. In this case, you are to find an exception. You have to select the condition that does not have to be met when using the grounded conductor of the circuit to ground the frame of the dryer. You should have selected **(C)** because Section 250-140 of the NEC requires the conditions listed in (A), (B), and (D) but does not require or permit the conditions listed in (C).

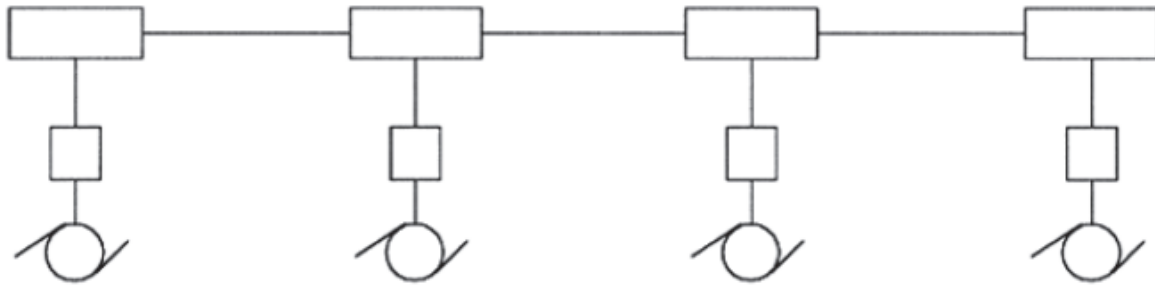

RATED		RATED		RATED		RATED	
FLA	6.6	CODE LET		FLA	10.6	CODE LET	
	208 V	TEMP RISE			208 V	TEMP RISE	
HP	1.5		3 $\phi$	HP	3		3 $\phi$
FLA	16.7	CODE LET		FLA	24.2	CODE LET	
	208 V	TEMP RISE			208 V	TEMP RISE	
HP	5		3 $\phi$	HP	7.5		3 $\phi$

**EXAMPLE 4:**

In the diagram shown above: Equipment terminations provided are 75°C and Type THW copper conductors in a raceway are used for feeder conductors. Which of the following is the minimum allowable size of the feeder conductors?

- (A)  (B)  (C)  (D)

- (A) 8 AWG
- (B) 6 AWG
- (C) 4 AWG
- (D) 2 AWG

Here you are asked to determine the smallest size of conductors that the NEC will allow for the feeder. Section 430.24 tells you that conductors supplying several motors shall have an ampacity not less than 125 percent of the full-load current rating of the highest rated motor plus the sum of the full-load current rating of all the other motors in the group. In this case, the total is 64 amps. This figure is then referenced to Table 310-15(B)(16), and according to the table, size 6 AWG, Type THW copper conductor has rated ampacity of 65 amps; therefore, you should have selected (B).

**EXAMPLE 5:**

Which of the following conditions shall be met to omit overcurrent protection at the tap point for a 20-ft. feeder tap?

- I. The tap conductor shall terminate in a panelboard.
- II. The ampacity of the tap conductors shall be at least one-half the ampacity of the feeder conductors.

- (A)  (B)  (C)  (D)

- (A) I only
- (B) II only
- (C) Both I and II
- (D) Neither I nor II

Here you are asked to determine which of two conditions are required by the NEC if a contractor omits an overcurrent device at a tap point. Section 240.21(B)(2) of the NEC lists three conditions that are required to be met when tap conductors are utilized in this manner. However, the question asks only about two conditions specifically stated, and since neither of them is included as a condition, you should have selected (D).

## PRACTICE QUESTIONS

### LIMITED, INTERMEDIATE, AND UNLIMITED EXAMINATIONS

Try to answer the practice questions that follow. Questions one (1) through thirty (30) are practice questions that are intended to illustrate the type of questions that appear on the examinations. Mark your answers on the **ANSWER SHEET FOR PRACTICE QUESTIONS**, which appears below. After you have answered all of the questions, compare the answers you have marked on the answer sheet with those given on the last page of practice questions in this bulletin. If you have difficulty with certain questions, you may wish to review that subject area before you take the examination.

### SPECIAL RESTRICTED EXAMINATIONS

SINGLE FAMILY DETACHED RESIDENTIAL DWELLING (SP-SFD), FIRE ALARM/LOW VOLTAGE (FALV), PLUMBING AND HEATING (SP-PH), ELECTRIC SIGN (SP-ES), ELEVATOR (SP-EL), GROUND WATER PUMP (SP-WP), AND SWIMMING POOL BONDING (SP-SP).

Questions thirty-one (31) through fifty-six (56) are practice questions that are intended to illustrate the type of questions that appear on the SPECIAL RESTRICTED EXAMINATIONS. Mark your answers on the **ANSWER SHEET FOR PRACTICE QUESTIONS**, which appears below. After you have answered all of the questions, compare the answers you have marked on the answer sheet with those given on the last page of practice questions in this bulletin. If you have difficulty with certain questions, you may wish to review that subject area before you take the examination.

### DIRECTIONS

Each question or incomplete statement is followed by four (4) suggested answers. In each case, select the **ONE** that best answers the question or completes the statement and then blacken the corresponding space on the answer sheet below.

### ANSWER SHEET

1. <input type="radio"/> A <input type="radio"/> B <input type="radio"/> C <input type="radio"/> D	11. <input type="radio"/> A <input type="radio"/> B <input type="radio"/> C <input type="radio"/> D	21. <input type="radio"/> A <input type="radio"/> B <input type="radio"/> C <input type="radio"/> D	31. <input type="radio"/> A <input type="radio"/> B <input type="radio"/> C <input type="radio"/> D	41. <input type="radio"/> A <input type="radio"/> B <input type="radio"/> C <input type="radio"/> D	51. <input type="radio"/> A <input type="radio"/> B <input type="radio"/> C <input type="radio"/> D
2. <input type="radio"/> A <input type="radio"/> B <input type="radio"/> C <input type="radio"/> D	12. <input type="radio"/> A <input type="radio"/> B <input type="radio"/> C <input type="radio"/> D	22. <input type="radio"/> A <input type="radio"/> B <input type="radio"/> C <input type="radio"/> D	32. <input type="radio"/> A <input type="radio"/> B <input type="radio"/> C <input type="radio"/> D	42. <input type="radio"/> A <input type="radio"/> B <input type="radio"/> C <input type="radio"/> D	52. <input type="radio"/> A <input type="radio"/> B <input type="radio"/> C <input type="radio"/> D
3. <input type="radio"/> A <input type="radio"/> B <input type="radio"/> C <input type="radio"/> D	13. <input type="radio"/> A <input type="radio"/> B <input type="radio"/> C <input type="radio"/> D	23. <input type="radio"/> A <input type="radio"/> B <input type="radio"/> C <input type="radio"/> D	33. <input type="radio"/> A <input type="radio"/> B <input type="radio"/> C <input type="radio"/> D	43. <input type="radio"/> A <input type="radio"/> B <input type="radio"/> C <input type="radio"/> D	53. <input type="radio"/> A <input type="radio"/> B <input type="radio"/> C <input type="radio"/> D
4. <input type="radio"/> A <input type="radio"/> B <input type="radio"/> C <input type="radio"/> D	14. <input type="radio"/> A <input type="radio"/> B <input type="radio"/> C <input type="radio"/> D	24. <input type="radio"/> A <input type="radio"/> B <input type="radio"/> C <input type="radio"/> D	34. <input type="radio"/> A <input type="radio"/> B <input type="radio"/> C <input type="radio"/> D	44. <input type="radio"/> A <input type="radio"/> B <input type="radio"/> C <input type="radio"/> D	54. <input type="radio"/> A <input type="radio"/> B <input type="radio"/> C <input type="radio"/> D
5. <input type="radio"/> A <input type="radio"/> B <input type="radio"/> C <input type="radio"/> D	15. <input type="radio"/> A <input type="radio"/> B <input type="radio"/> C <input type="radio"/> D	25. <input type="radio"/> A <input type="radio"/> B <input type="radio"/> C <input type="radio"/> D	35. <input type="radio"/> A <input type="radio"/> B <input type="radio"/> C <input type="radio"/> D	45. <input type="radio"/> A <input type="radio"/> B <input type="radio"/> C <input type="radio"/> D	55. <input type="radio"/> A <input type="radio"/> B <input type="radio"/> C <input type="radio"/> D
6. <input type="radio"/> A <input type="radio"/> B <input type="radio"/> C <input type="radio"/> D	16. <input type="radio"/> A <input type="radio"/> B <input type="radio"/> C <input type="radio"/> D	26. <input type="radio"/> A <input type="radio"/> B <input type="radio"/> C <input type="radio"/> D	36. <input type="radio"/> A <input type="radio"/> B <input type="radio"/> C <input type="radio"/> D	46. <input type="radio"/> A <input type="radio"/> B <input type="radio"/> C <input type="radio"/> D	56. <input type="radio"/> A <input type="radio"/> B <input type="radio"/> C <input type="radio"/> D
7. <input type="radio"/> A <input type="radio"/> B <input type="radio"/> C <input type="radio"/> D	17. <input type="radio"/> A <input type="radio"/> B <input type="radio"/> C <input type="radio"/> D	27. <input type="radio"/> A <input type="radio"/> B <input type="radio"/> C <input type="radio"/> D	37. <input type="radio"/> A <input type="radio"/> B <input type="radio"/> C <input type="radio"/> D	47. <input type="radio"/> A <input type="radio"/> B <input type="radio"/> C <input type="radio"/> D	
8. <input type="radio"/> A <input type="radio"/> B <input type="radio"/> C <input type="radio"/> D	18. <input type="radio"/> A <input type="radio"/> B <input type="radio"/> C <input type="radio"/> D	28. <input type="radio"/> A <input type="radio"/> B <input type="radio"/> C <input type="radio"/> D	38. <input type="radio"/> A <input type="radio"/> B <input type="radio"/> C <input type="radio"/> D	48. <input type="radio"/> A <input type="radio"/> B <input type="radio"/> C <input type="radio"/> D	
9. <input type="radio"/> A <input type="radio"/> B <input type="radio"/> C <input type="radio"/> D	19. <input type="radio"/> A <input type="radio"/> B <input type="radio"/> C <input type="radio"/> D	29. <input type="radio"/> A <input type="radio"/> B <input type="radio"/> C <input type="radio"/> D	39. <input type="radio"/> A <input type="radio"/> B <input type="radio"/> C <input type="radio"/> D	49. <input type="radio"/> A <input type="radio"/> B <input type="radio"/> C <input type="radio"/> D	
10. <input type="radio"/> A <input type="radio"/> B <input type="radio"/> C <input type="radio"/> D	20. <input type="radio"/> A <input type="radio"/> B <input type="radio"/> C <input type="radio"/> D	30. <input type="radio"/> A <input type="radio"/> B <input type="radio"/> C <input type="radio"/> D	40. <input type="radio"/> A <input type="radio"/> B <input type="radio"/> C <input type="radio"/> D	50. <input type="radio"/> A <input type="radio"/> B <input type="radio"/> C <input type="radio"/> D	

### Limited, Intermediate, and Unlimited Questions

#### Questions 1 – 30

Questions one (1) and two (2) are to be answered by using the *Lighting and Power Plans* (see back of handbook).

1. What type of fluorescent lamps must be supplied?
  - (A) Daylight
  - (B) Cool white
  - (C) Warm white
  - (D) Warm white deluxe
  
2. The total wattage for all lamps supplied by multiwire branch circuit A5, 7 is:
  - (A) 480 watts
  - (B) 860 watts
  - (C) 1340 watts
  - (D) 2200 watts



3. A single-family dwelling contains a 200-amp 1Ø main-service panel with 75°C equipment terminations and is being supplied with size 2/0 AWG, Type THW copper conductors in rigid metal conduit. The minimum allowable size of the bonding jumper for this service-entrance conduit is:
  - (A) 6 AWG aluminum
  - (B) 6 AWG copper
  - (C) 4 AWG aluminum
  - (D) 4 AWG copper
  
4. Which of the following statements about supplementary overcurrent protection is correct?
  - (A) It shall be readily accessible.
  - (B) It shall not be used in luminaries.
  - (C) It may be used to protect internal circuits of equipment.
  - (D) It may be used as a substitute for a branch-circuit overcurrent device.
  
5. Disregarding all exceptions. Which of the following statements about Type MI cable is correct?
  - (A) It may be used in any hazardous location.
  - (B) It shall not be used where exposed to oil and gasoline.
  - (C) It shall be securely supported at intervals not exceeding 10 ft.
  - (D) A single run of cable shall not contain more than the equivalent of 4 quarter bends.
  
6. Which of the following statements about the protection of nonmetallic-sheathed cable from physical damage is/are correct?
  - I. When run across the top of floor joists in an accessible attic, the cable shall be protected by approved guard strips.
  - II. When passing through a floor, the cable could be enclosed in Schedule 40 PVC rigid nonmetallic conduit extending at least 6 in. above the floor.
  - (A) I only
  - (B) II only
  - (C) Both I and II
  - (D) Neither I nor II
  
7. The maximum allowable ampacity of each of three-(3) single insulated 75°C rated size 6 AWG copper conductors in a raceway is:
  - (A) 55 amps
  - (B) 65 amps
  - (C) 70 amps
  - (D) 80 amps
  
8. Which of the following statements about an enclosed type single-throw knife switch is/are correct?
  - I. The switch shall be placed so that gravity will not tend to close the blades.
  - II. A switch approved for inverted mounting shall be provided with a locking device that will ensure that the blades remain in the open position when so set.
  - (A) I only
  - (B) II only
  - (C) Both I and II
  - (D) Neither I nor II
  
9. Which of the following statements about a size 2 AWG, Type THHN copper conductor is correct?
  - (A) It has nylon insulation.
  - (B) Its area is .067 square inches.
  - (C) Its maximum operating temperature is 90°C.
  - (D) It has a standard DC resistance of .266 ohms per 1000 ft.
  
10. A panelboard without individual protection contains six-(6) 3-pole circuit breakers and eight-(8) 2-pole circuit breakers. The maximum number of single-pole circuit breakers permitted to be added in this panelboard is:
  - (A) 8
  - (B) 16
  - (C) 28
  - (D) 42



11. A metal device box contains cable clamps, six-(6) size 14 AWG conductors, and one-(1) single-pole switch. What is the minimum allowable size of the box?
  - (A) 12 cu. in.
  - (B) 13 1/2 cu. in.
  - (C) 14 1/4 cu. in.
  - (D) 18 cu. in.
  
12. A 120/240V, 3-wire service-drop passing over a residential driveway shall have a minimum height above grade of:
  - (A) 10 ft.
  - (B) 12 ft.
  - (C) 15 ft.
  - (D) 18 ft.
  
13. Which of the following statements about 120/240V, 3-wire service-entrance conductors for a one-family dwelling is/are correct?
  - I. The service disconnecting means shall have a rating of not less than 100 amperes, 3-wire.
  - II. Service conductors shall be permitted to be connected to the service disconnecting means by connections that depend on solder.
  - (A) I only
  - (B) II only
  - (C) Both I and II
  - (D) Neither I nor II
  
14. Which of the following may be used as a feeder from the service equipment to a mobile home?
  - I. A permanently installed feeder.
  - II. One 50-ampere power-supply cord.
  - (A) I only
  - (B) II only
  - (C) Either I or II
  - (D) Neither I nor II
  
15. Which of the following statements about the inspection of electrical work is/are correct?
  - I. Inspectors shall make as many inspections as are necessary to ensure compliance with applicable laws.
  - II. An inspector shall issue a certificate of compliance when the completed electrical installation complies with all applicable laws and with the terms of the permit.
  - (A) I only
  - (B) II only
  - (C) Both I and II
  - (D) Neither I nor II
  
16. A 208V, 50 hp, 3Ø squirrel-cage motor has a full-load current rating of:
  - (A) 130 amps
  - (B) 143 amps
  - (C) 162 amps
  - (D) 195 amps
  
17. Which of the following is the maximum allowable rating of a permanently connected appliance where the branch-circuit overcurrent device is used as the appliance disconnecting means?
  - (A) 1/8 hp.
  - (B) 1/4 hp.
  - (C) 1/2 hp.
  - (D) 1 hp.

18. A 75 kva transformer has a 480V, 3Ø, 3-wire delta primary and a 208/120V, 3Ø, 4-wire wye secondary and is fed from a 225-amp plug-in bus duct protected by a 225-amp circuit breaker. Primary and secondary overcurrent protection is being required for this installation. Which of the following statements about overcurrent protection for this transformer is/are correct?
- I. It shall have a primary overcurrent device rated at not more than 200-amps.
  - II. It shall be permissible to have a single nonadjustable overcurrent device on the secondary side rated at not more than 300-amps.
- (A) I only  
 (B) II only  
 (C) Both I and II  
 (D) Neither I nor II
19. A store building measures 60 ft. by 80 ft. and is supplied by a 240/120V, 3Ø, 4-wire delta system. Which of the following is the minimum allowable number of 2-wire, 20-ampere branch circuits required to supply the general lighting in this building?
- (A) 2  
 (B) 7  
 (C) 4  
 (D) 5

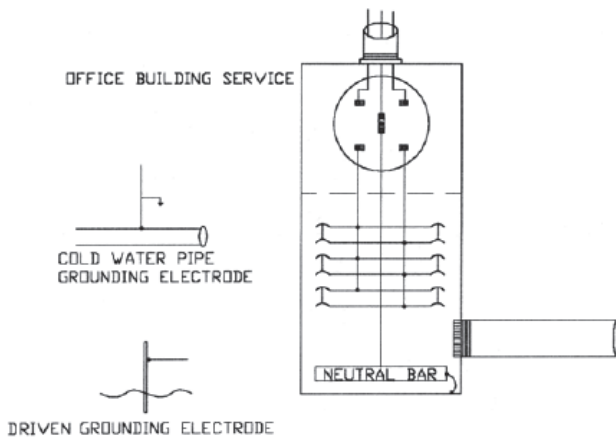

20. In the diagram shown above: The total calculated load for the service is 200 amps for each ungrounded conductor and 60 amps maximum unbalanced load for the grounded conductor. Equipment terminations provided are 75°C and Type THW copper conductors are used. The minimum allowable size of the grounded conductor is:
- (A) 6 AWG  
 (B) 4 AWG  
 (C) 2/0 AWG  
 (D) 3/0 AWG

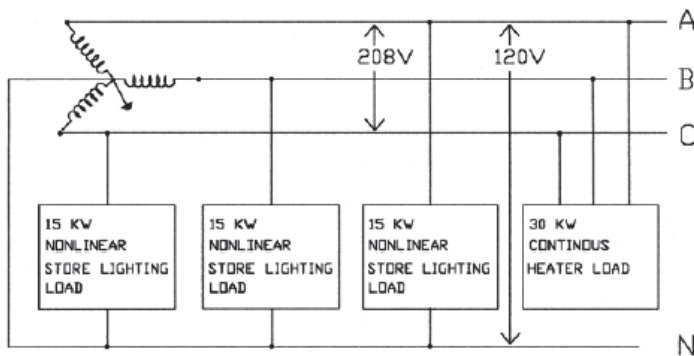

21. In the diagram shown above: The total load that conductor A is supplying in the feeder is:
- (A) 208 amps  
 (B) 216 amps  
 (C) 260 amps  
 (D) 270 amps

22. The minimum standard size fuse required to protect conductor A in the feeder shown above question #21 is:
- (A) 200 amps
  - (B) 225 amps
  - (C) 250 amps
  - (D) 300 amps
23. Equipment terminations provided are 75°C and Type THHN copper conductors in conduit are to be used. The minimum allowable size of the ungrounded conductors in the feeder shown above question #21 is:
- (A) 4/0 AWG
  - (B) 250 kcmil
  - (C) 300 kcmil
  - (D) 350 kcmil
24. In dwelling units, ground-fault circuit-interrupter protection is required in all of the following locations **EXCEPT**:
- (A) Garages
  - (B) Outdoors
  - (C) Bedrooms
  - (D) Bathrooms
25. In noncombustible walls or ceilings, the front edge of an outlet box may be set back of the finished surface not more than:
- (A) 1/8 in.
  - (B) 1/4 in.
  - (C) 1/2 in.
  - (D) 3/4 in.
26. The rating of any one cord-and plug-connected utilization equipment on a 120V, 15-ampere branch-circuit which has only one outlet shall not exceed:
- (A) 12 amps
  - (B) 15 amps
  - (C) 16 amps
  - (D) 20 amps
27. The total rating of a cord-and-attachment-plug-connected room air conditioner connected to a 20-ampere branch-circuit that does not employ interlocking circuitry to prevent simultaneous operation of lighting outlets of the same circuit shall not exceed:
- (A) 10 amps
  - (B) 15 amps
  - (C) 16 amps
  - (D) 20 amps
28. Which of the following statements about the mounting of electric equipment is/are correct?
- I. Electric equipment shall be firmly secured to the surface on which it is mounted.
  - II. Wooden plugs driven into holes in masonry, concrete, plaster, or similar materials shall not be used.
- (A) I only
  - (B) II only
  - (C) Both I and II
  - (D) Neither I nor II
29. A 240V, 1Ø, 21.85 KW commercial cooking appliance is to be supplied by Type TW copper branch circuit conductors. Which of the following is the minimum allowable size of the conductors?
- (A) 3 AWG
  - (B) 2 AWG
  - (C) 1 AWG
  - (D) 1/0 AWG
30. A 230V, 5HP, 3Ø squirrel-cage motor has a full-load current rating of 15.2 amperes. The standard rating of a dual element (time-delay) fuse used to provide branch-circuit short-circuit and ground-fault protection shall be permitted to be:
- (A) 20 amps
  - (B) 25 amps
  - (C) 30 amps
  - (D) 35 amps

## Special Restricted Practice Questions

## QUESTIONS 31 - 56

## Special Restricted Single-Family Detached Residential Dwelling (SP-SFD): Questions 31 - 34

31. A 240V, 1Ø branch-circuit will supply an electric furnace that has elements rated at 12 kva and a motor rated at 1.5 kva. Equipment terminations provided are 75°C and Type THW copper conductors are to be used. What is the minimum allowable size of the branch-circuit conductors?
- (A) 6 AWG
  - (B) 4 AWG
  - (C) 2 AWG
  - (D) 1 AWG
32. A branch circuit is supplying a single hermetic refrigerant motor-compressor for an air conditioning unit. The hermetic refrigerant motor-compressor-rated-load current is 18 amperes. If a 30-ampere fuse will not start the motor-compressor, the maximum rating of the branch-circuit short-circuit and ground-fault protective device may be increased to:
- (A) 35 amps
  - (B) 40 amps
  - (C) 45 amps
  - (D) 50 amps
33. The minimum number of 120V, 15-ampere, 2-wire lighting branch-circuits required for a residence 70 ft. by 30 ft. is:
- (A) 2
  - (B) 3
  - (C) 4
  - (D) 5
34. An individual 20-ampere rated branch-circuit serves a single receptacle. The rating of the receptacle must not be less than:
- (A) 12 amps
  - (B) 15 amps
  - (C) 16 amps
  - (D) 20 amps

## Special Restricted Fire Alarm Low-Voltage (SP-FALV): Questions 35 - 38

35. The maximum allowable ampacity of size 18 AWG conductors suitable for a fire protection system is:
- (A) 6 amps
  - (B) 8 amps
  - (C) 14 amps
  - (D) 18 amps
36. Where ceiling heights allow, wall-mounted fire alarm signal devices shall have their tops at heights above the finished floors of not less than:
- (A) 48 in.
  - (B) 60 in.
  - (C) 72 in.
  - (D) 90 in.
37. A metal box with cable clamps contains two-(2) size 14 AWG, two conductor nonmetallic-sheathed cables with an equipment grounding conductor. Which of the following is the minimum allowable capacity of the box?
- (A) 12 cu. in.
  - (B) 14 cu. in.
  - (C) 16 cu. in.
  - (D) 18 cu. in.
38. The rating of the branch circuit overcurrent device supplying a low voltage wiring system is fifteen (15) amperes. The minimum allowable size equipment grounding conductor required for this dedicated circuit is:
- (A) 14 AWG copper
  - (B) 14 AWG aluminum
  - (C) 12 AWG copper
  - (D) 10 AWG aluminum

**Special Restricted Plumbing and Heating (SP-PH): Questions 39 - 42**

39. Disregarding all exceptions. All phase conductors and, where used, the grounded conductor and all equipment conductors of an alternating current circuit shall be grouped together when installed in metal raceways to avoid heating caused by:
- Ampacity
  - Induction
- I only
  - II only
  - Both I and II
  - Neither I nor II
40. The minimum size liquid tight flexible metal conduit is:
- 3/8 in.
  - 1/2 in.
  - 3/4 in.
  - 1 in.
41. A load is considered to be continuous if the maximum current is expected to continue for:
- 1/2 hour
  - 1 hour
  - 2 hours
  - 3 hours
42. The maximum length of a flexible cord identified as suitable for the purpose of connecting a built-in dishwasher shall be:
- 2 ft.
  - 3 ft.
  - 6.5 ft.
  - 5 ft.

**Special Restricted Electric Sign (SP-ES): Questions 43 - 46**

43. The minimum allowable trade size of a rigid, PVC conduit, Schedule 40, containing four-(4) size 8 AWG, Type TW copper conductors is:
- 1/2
  - 3/4
  - 1
  - 1 1/2
44. Type TW insulation has a temperature rating of:
- 60°C
  - 75°C
  - 90°C
  - 110°C
45. Unless otherwise specifically permitted elsewhere in the NEC, which one of the following is the maximum overcurrent protection for three-(3) size 12 AWG, Type THWN copper conductors installed in a raceway?
- 15 amps
  - 20 amps
  - 25 amps
  - 30 amps
46. Which of the following statements about liquidtight flexible metal conduit is/are correct?
- Angle connectors shall not be used for concealed raceway installations.
  - Liquidtight flexible metal conduit shall not be used where subject to physical damage.
- I only
  - II only
  - Both I and II
  - Neither I nor II

**Special Restricted Elevator (SP-EL): Questions 47 - 50**

47. The full-load current of a 240V direct-current 7 ½ hp motor is:
- (A) 19 amps
  - (B) 22 amps
  - (C) 29 amps
  - (D) 38 amps
48. All of the following are standard ampere ratings for inverse time circuit breakers **EXCEPT**:
- (A) 275
  - (B) 300
  - (C) 350
  - (D) 400
49. A metal outlet device box contains eight-(8) size 12 AWG conductors. Which of the following is the minimum allowable box dimension:
- (A) 4 x 1 1/4 in. square
  - (B) 4 x 1 1/2 in. square
  - (C) 4 x 2 1/8 in. square
  - (D) 4 x 2 1/8 in. octagonal
50. The ampacity of a feeder supplying one-(1) 7 ½ HP-240 volt direct-current motor and one-(1) 10 HP-240 volt direct-current motor shall not be less than:
- (A) 56 amps
  - (B) 74 amps
  - (C) 77 amps
  - (D) 84 amps

**Special Restricted Ground Water Pump (SP-WP): Questions 51 - 54**

51. Motor overload protection devices are intended to protect:
- I. Motors due to overload.
  - II. Motors with short circuits or ground faults.
- (A) I only
  - (B) II only
  - (C) Both I and II
  - (D) Neither I nor II
52. An equipment bonding jumper is permitted outside a raceway:
- (A) When not over 5 ft. long.
  - (B) When not over 6 ft. long.
  - (C) When not over 8 ft. long.
  - (D) When not over 10 ft. long.
53. The identification of the terminal intended for connection of the grounded conductor to a polarized receptacle can be identified by a metal or metal coating that is substantially:
- (A) Gold in color.
  - (B) White in color.
  - (C) Green in color.
  - (D) Yellow in color.
54. The maximum allowable ampacity of three-(3) single insulated 75°C rated size 6 AWG copper conductors in a raceway is:
- (A) 55 amps
  - (B) 65 amps
  - (C) 70 amps
  - (D) 80 amps

**Special Restricted Swimming Pool Bonding (SP-SP): Questions 55 - 56**

55. Which one of the following is the minimum size conductor permitted to be used for the bonding conductor in a swimming pool installation?
- (A) 10 AWG stranded copper conductor
  - (B) 10 AWG solid copper conductor
  - (C) 8 AWG solid copper conductor
  - (D) 8 AWG stranded copper conductor
56. Which of the following statements about the Board's rules (Title 21 NCAC 18B) is/are correct?
- I. All licensees must notify the Board in writing within 30 days of any change of mailing address and telephone number.
  - II. All electrical contracting business, including all business advertising and the submission of all documents and papers, conducted in the state of North Carolina by a licensee of the Board shall be conducted in the exact name in which the electrical contracting license is issued.
- (A) I only
  - (B) II only
  - (C) Both I and II
  - (D) Neither I nor II

**ANSWER KEY FOR PRACTICE QUESTIONS**

1. B	11. D	21. A	31. B	41. D	51. A
2. C	12. B	22. D	32. B	42. C	52. B
3. D	13. A	23. C	33. C	43. B	53. B
4. C	14. C	24. C	34. D	44. A	54. B
5. A	15. C	25. B	35. A	45. B	55. C
6. A	16. B	26. A	36. D	46. C	56. C
7. B	17. A	27. A	37. A	47. C	
8. C	18. B	28. C	38. A	48. A	
9. C	19. C	29. B	39. B	49. A	
10. A	20. B	30. C	40. A	50. C	

## NORTH CAROLINA ELECTRICAL CONTRACTORS LICENSING LAW

### CHAPTER 87 - ARTICLE 4

#### *Electrical Contractors*

87-39.	Board of Examiners; appointment; terms; chairman; meetings; quorum; principal office; compensation; oath.
87-40.	Secretary-treasurer.
87-41.	Seal of Board.
87-41.1.	Definitions.
87-42.	Duties and powers of Board.
87-43.	Electrical contracting defined; licenses.
87-43.1.	Exceptions.
87-43.2.	Issuance of license.
87-43.3.	Classification of licenses.
87-43.4.	Residential dwelling license.
87-44.	Fees; license term.
87-44.1.	Continuing education courses required.
87-45.	Funds.
87-46.	Responsibility of licensee; nonliability of Board.
87-47.	Penalties imposed by Board; enforcement procedures.
87-48.	Penalty for violation of Article; powers of Board to enjoin violation.
87-49.	No examination required of licensed contractors.
87-50.	Reciprocity.
87-50.1.	Public awareness program.
87-51.	Severability of provisions.

#### **87-39. BOARD OF EXAMINERS; APPOINTMENT; TERMS; CHAIRMAN; MEETINGS; QUORUM; PRINCIPAL OFFICE; COMPENSATION; OATH.**

- (a) The State Board of Examiners of Electrical Contractors shall continue as the State agency responsible for the licensing of persons engaging in electrical contracting within this State, and shall consist of one member from the North Carolina Department of Insurance to be designated by the Commissioner of Insurance; one member who has satisfied the requirements for an unlimited license as defined in G.S. 87-43.3 and who is a representative of the North Carolina Association of Electrical Contractors to be designated by the governing body of that organization; and five members to be appointed by the Governor: one from the faculty of The Greater University of North Carolina who teaches or does research in the field of electrical engineering, one who is serving as a chief electrical inspector of a municipality or county in North Carolina, one who has satisfied the requirements for an unlimited license as defined in G.S. 87-43.3 and who is a representative of the Carolinas Electrical Contractors Association operating a sole proprietorship, partnership or corporation located in North Carolina which is actively engaged in the business of electrical contracting, and two who have no ties with the construction industry and who represent the interest of the public at large.
- (b) Members of the Board shall serve staggered seven-year terms. Each member shall serve until his or her successor is designated or appointed and is duly qualified. Vacancies occurring during a term shall be filled for the remainder of that term by the authority that designated or appointed the departing member.
- (c) Members of the Board shall not serve consecutive, complete terms. For purposes of this subsection, only a term of less than seven years that results from the filling of a vacancy is an incomplete term; a term of less than seven years that results from the successor's late designation or appointment is not an incomplete term.
- (d) All members shall be residents of North Carolina during their tenure on the Board. Any member of the Board may be removed by the authority that designated or appointed that member for misconduct, incompetency, or neglect of duty.
- (e) The Board shall hold regular meetings quarterly and may hold meetings on call of the chair. The chair shall be required to call a special meeting upon written request by two members of the Board. At its regular first quarter meeting, the Board shall elect from its membership a chair and a vice-chair, each to serve for one year. Four members of the Board shall constitute a quorum. The principal office of the Board shall be at such place as shall be designated by a majority of the members thereof. Payment of compensation and reimbursement of expenses of Board members shall be governed by G.S. 93B-5.
- (f) Before entering upon the performance of his or her duties hereunder, each member of the Board shall take and file with the Secretary of State an oath in writing to properly perform the duties of his or her office as a member of the Board, and to uphold the Constitution of North Carolina and the Constitution of the United States.

#### **87-40. SECRETARY-TREASURER.**

At its regular first quarter meeting, the Board shall appoint a secretary-treasurer to serve for one year. The secretary-treasurer need not be a member of the Board, and the Board is authorized to employ a full-time secretary-treasurer and such other assistants and to make such other expenditures as may





be necessary to the proper performance of the duties of the Board under this Article. The compensation and the duties of the secretary-treasurer shall be fixed by the Board, and the secretary-treasurer shall give bond in such sum and form as the Board shall require for the faithful performance of duty. The secretary-treasurer shall keep a record of the proceedings of said Board and shall receive and account for all moneys derived from the operations of the Board under this Article.

#### **87-41. SEAL OF BOARD.**

The Board shall adopt a seal for its own use, and the secretary-treasurer shall have charge and custody thereof. The seal shall have inscribed thereon the words "Board of Examiners of Electrical Contractors, State of North Carolina."

##### **87-41.1. DEFINITIONS.**

As used in this Article, unless the context requires otherwise:

- 1) A "qualified individual" is an individual who is qualified in a specific license classification as a result of having taken and passed the qualifying examination required by this Article for such a classification and who has been certified as such by the Board pursuant to G.S. 87-42.
- 2) A "listed qualified individual" is a qualified individual whose name is listed on a license issued by the Board. A listed qualified individual has the specific duty and authority to supervise and direct electrical contracting done by or in the name of a licensee of the Board on whose license the qualified individual is so listed.
- 3) A licensee of the Board is a person listed pursuant to subsection (2), or a partnership, firm or corporation that regularly employs at least one listed qualified individual and which has been issued a license by the Board.

#### **87-42. DUTIES AND POWERS OF BOARD.**

In order to protect the life, health and property of the public, the State Board of Examiners of Electrical Contractors shall provide for the written examination of all applicants for certification as a qualified individual, as defined in G.S. 87-41.1. The Board shall receive all applications for certification as a qualified individual and all applications for licenses to be issued under this Article, shall examine all applicants to determine that each has met the requirements for certification and shall discharge all duties enumerated in this Article. Applicants for certification as a qualified individual must be at least 18 years of age and shall be required to demonstrate to the satisfaction of the Board their good character and adequate technical and practical knowledge concerning the safe and proper installation of electrical work and equipment. The examination to be given for this purpose shall include, but not be limited to, the appropriate provisions of the National Electrical Code as incorporated in the North Carolina State Building Code, the analysis of electrical plans and specifications, estimating of electrical installations, and the fundamentals of the installation of electrical work and equipment. Certification of qualified individuals shall be issued in the same classifications as provided in this Article for license classifications. The Board shall prescribe the standards of knowledge, experience, and proficiency to be required of qualified individuals, which may vary for the various license classifications. The Board shall issue certifications and licenses to all applicants meeting the requirements of this Article and of the Board upon the receipt of the fees prescribed by G.S. 87-44. The Board shall have power to make rules and regulations necessary to the performance of its duties and for the effective implementation of the provisions of this Article. The Board shall have the power to administer oaths and issue subpoenas requiring the attendance of persons and the production of papers and records before the Board in any hearing, investigation, or proceeding conducted by it. Members of the Board's staff or the sheriff or other appropriate official of any county of this State shall serve all notices, subpoenas, and other papers given to them by the Chairman for service in the same manner as process issued by any court of record. Any person who neglects or refuses to obey a subpoena issued by the Board shall be guilty of a Class 1 misdemeanor. The Board shall have the power to acquire, rent, encumber, alienate, and otherwise deal with real property in the same manner as a private person or corporation, subject only to approval of the Governor and the Council of State. Collateral pledged by the Board for an encumbrance is limited to the assets, income, and revenue of the Board. The Board shall keep minutes of all its proceedings and shall keep an accurate record of receipts and disbursements which shall be audited at the close of each fiscal year by a certified public accountant, and the audit report shall be filed with the State of North Carolina in accordance with Chapter 93B of the General Statutes.

#### **87-43. ELECTRICAL CONTRACTING DEFINED; LICENSES.**

Electrical contracting shall be defined as engaging or offering to engage in the business of installing, maintaining, altering, or repairing any electric work, wiring, devices, appliances, or equipment. No person, partnership, firm, or corporation shall engage, or offer to engage, in the business of electrical contracting within the State of North Carolina without having received a license in the applicable classification described in G.S. 87-43.3 from the State Board of Examiners of Electrical Contractors in compliance with the provisions of this Article, regardless of whether the offer was made or the work was performed by a qualified individual as defined in G.S. 87-41.1. In each separate place of business operated by an electrical contractor at least one listed qualified individual shall be regularly on active duty and shall have the specific duty and authority to supervise and direct all electrical wiring or electrical installation work done or made by such separate place of business. Every person, partnership, firm, or corporation engaging in the business of electrical contracting shall display a current certificate of license in his principal place of business and in each branch place of business which he operates. Licenses issued hereunder shall be signed by the chairman and the secretary-treasurer of the Board, under the seal of the Board. A registry of all licenses issued to electrical contractors shall be kept by the secretary-treasurer of the Board and said registry shall be open for public inspection during ordinary business hours.

##### **87-43.1. EXCEPTIONS.**

The provisions of this Article shall not apply:

- 1) To the installation, construction, or maintenance of facilities for providing electric service to the public ahead of the point of delivery of electric service to the customer;



- 2) To the installation, construction, maintenance, or repair of telephone, telegraph, or signal systems, by public utilities, or their corporate affiliates, when said work pertains to the services furnished by said public utilities;
- 3) To any person in the course of his work as a bona fide employee of a licensee of this Board;
- 4) To the installation, construction or maintenance of electrical equipment and wiring for temporary use by contractors in connection with the work of construction;
- 5) To the installation, construction, maintenance or repair of electrical wiring, devices, appliances or equipment by persons, firms or corporations, upon their own property when such property is not intended at the time for rent, lease, sale or gift, who regularly employ one or more electricians or mechanics for the purpose of installing, maintaining, altering or repairing of electrical wiring, devices or equipment used for the conducting of the business of said persons, firms or corporations.
- (5a) To any person when that person is installing, maintaining, altering, or repairing electric work, wiring, devices, appliances or equipment upon that person's own property and for that person's own benefit when such property is not intended at the time for rent, lease, or sale. This subdivision shall not be construed to limit the ability of local boards of education, hospitals as defined in G.S. 131E-76, or nonprofit organizations exempt from taxation under section 501(C)(3) of the Internal Revenue Code (26 U.S.C.501(C)(3), to employ personnel who are licensed under this Article to perform maintenance and repairs on property owned or in the possession of that local board of education, hospital, or nonprofit organization.
- 6) To the installation, construction, maintenance or repair of electrical wiring, devices, appliances or equipment by State institutions and private educational institutions which maintain a private electrical department;
- 7) To the replacement of lamps and fuses and to the installation and servicing of cord-connected appliances and equipment connected by means of attachment plug-in devices to suitable receptacles which have been permanently installed or to the servicing of appliances connected to a permanently installed junction box. This exception does not apply to permanently installed receptacles or to the installation of the junction box.
- 8) To the bonding of corrugated stainless-steel tubing (CSST) gas piping systems as required under Section 310.1.1 of the 2012 N.C. Fuel Gas Code.
- 9) To the installation, maintenance, or replacement of any load control device or equipment by an electric power supplier, as defined in G.S. 62-133.8, or an electrical contractor contracted by the electric power supplier, so long as the work is subject to supervision by an electrical contractor licensed under this Article. The electric power supplier shall provide such installation, maintenance, or replacement in accordance with (i) an activity or program ordered, authorized, or approved by the North Carolina Utilities Commission pursuant to G.S. 62-133.8 or G.S. 62-133.9 or (ii) a similar program undertaken by a municipal electric service provider, whether the installation, modification, or replacement is made before or after the point of delivery of electric service to the customer. The exemption under this subdivision applies to all existing installations.
- 10) To the installation, construction, maintenance, or repair of electrical wiring, devices, appliances, or equipment by a person certified as a well contractor under Article 7A of this Chapter when running electrical wires from the well pump to the pressure switch.

*History Note: Eff. 1937, c.87, s.5; 1951, c.650, ss.1-21/2; 1953, c. 595; 1961, c.1165; 1969, c. 669, s.1; 1979, c. 904, ss. 4-7; 2013-36, s.1; 2013-58, s.1.*

#### **87-43.2. ISSUANCE OF LICENSE.**

- (a) A person, partnership, firm, or corporation shall be eligible to be licensed as an electrical contractor and to have such license renewed, subject to the provisions of this Article, provided:
  - 1) At least one listed qualified individual shall be regularly employed by the applicant at each separate place of business to have the specific duty and authority to supervise and direct electrical contracting done by or in the name of the licensee;
  - 2) An application is filed with the Board which contains a statement of ownership, states the names and official positions of all employees who are listed qualified individuals and provides such other information as the Board may reasonably require;
  - 3) The applicant, through an authorized officer or owner, shall agree in writing to report to the Board within five days any additions to or loss of the employment of listed qualified individuals; and
  - 4) The applicant furnishes, upon the initial application for a license, a bonding ability statement completed by a bonding company licensed to do business in North Carolina, verifying the applicant's ability to furnish performance bonds for electrical contracting projects having a value in excess of the project value limit for a limited license established pursuant to G.S. 87-43.3 for the intermediate license classification and in excess of the project value limit for a limited license established pursuant to G.S. 87-43.3 for the unlimited license classification. In lieu of furnishing the bonding ability statement, the applicant may submit for evaluation and specific approval of the Board other information certifying the adequacy of the applicant's financial ability to engage in projects of the license classification applied for. The bonding ability statement or other financial information must be submitted in the same name as the license to be issued. If the firm for which a license application is filed is owned by a sole proprietor, the bonding ability statement or other financial information may be furnished in either the firm name or the name of the proprietor. However, if the application is submitted in the name of a sole proprietor, the applicant shall submit information verifying that the person in whose name the application is made is in fact the sole proprietor of the firm.
- (b) A license shall indicate the names and classifications of all listed qualified individuals employed by the applicant. A license shall be cancelled if at any time no listed qualified individual is regularly employed by the applicant; provided, that work begun prior to such cancellation may be completed under such conditions as the Board shall direct; and provided further that no work for which a license is required under this Article may be bid for, contracted for, or initiated subsequent to such cancellation until said license is reinstated by the Board.
- (c) Nothing in this Article shall be deemed to limit the ability of a licensee under this Article who is regularly employed by a local board of education, a hospital as defined in G.S. 131E-76, or a nonprofit organization exempt from taxation under section 501(c)(3) of the Internal Revenue Code (26

U.S.C. 501 (c)(3)) to maintain an individual license or to contract or perform work at the direction of the local board of education, hospital or nonprofit organization for any building or facility owned or in possession of that local board of education, hospital, or nonprofit organization, regardless of whether all or a portion of that building or facility is being leased or otherwise provided for another entity or event”.

### **87-43.3. CLASSIFICATION OF LICENSES.**

An electrical contracting license shall be issued in one of the following classifications: Limited, under which a licensee shall be permitted to engage in a single electrical contracting project of a value, as established by the Board, not in excess of one hundred thousand dollars (\$100,000) (*please note the actual amount is sixty thousand dollars (\$60,000) by rule .0303.4*) and on which the equipment or installation in the contract is rated at not more than 600 volts; Intermediate, under which a licensee shall be permitted to engage in a single electrical contracting project of a value, as established by the Board, not in excess of two hundred thousand dollars (\$200,000) (*please note the actual amount is one hundred fifty thousand dollars (\$150,000) by rule .303.4*) Unlimited, under which a licensee shall be permitted to engage in any electrical contracting project regardless of value; and such other special Restricted classifications as the Board may establish from time to time to provide, (i) for the licensing of persons, partnerships, firms or corporations wishing to engage in special restricted electrical contracting, under which license a licensee shall be permitted to engage only in a specific phase of electrical contracting of a special, limited nature, and (ii) for the licensing of persons, partnerships, firms or corporations wishing to engage in electrical contracting work as an incidental part of their primary business, which is a lawful business other than electrical contracting, under which license a licensee shall be permitted to engage only in a specific phase of electrical contracting of a special, limited nature directly in connection with said primary business. The Board may establish appropriate standards for each classification, such standards not to be inconsistent with the provisions of G.S. 87-42. The Board may, by rule, modify the project value limitations up to the maximum amounts set forth in this section for limited and intermediate licenses no more than once every three years based upon an increase or decrease in the project cost index for electrical projects in this state.

### **87-43.4. RESIDENTIAL DWELLING LICENSE.**

There is hereby created a separate license for electrical contractors which shall permit an electrical contractor to engage in electrical contracting projects pertaining to single-family detached residential dwellings. The value of a single project pertaining to a single-family detached residential dwelling shall not be in excess of the maximum value, established in G.S. 87-43.3, of a single project engaged in by a licensee with a license classified as limited. The Board shall establish appropriate standards for this new license. The standards of knowledge, experience and proficiency shall be those appropriate for that license.

### **87-44. FEES ; LICENSE TERM.**

The Board shall collect a fee from each applicant before granting or renewing a license under the provisions of this Article; the annual license fee for the limited classification shall not exceed one hundred dollars (\$100.00) for each principal and each branch place of business; the annual license fee for the intermediate classification shall not exceed one hundred fifty dollars (\$150.00) for each principal and each branch place of business; the annual license fee for the unlimited classification shall not exceed two hundred dollars (\$200.00) for each principal and each branch place of business; and the annual license fee for the special restricted classifications and for the single-family detached residential dwelling license shall not exceed one hundred dollars (\$100.00) for each principal and each branch place of business. The Board shall establish a system for the renewal of licenses with varying expiration dates. However, all licenses issued by the Board shall expire one year after the date of issuance. Licenses shall be renewed by the Board, subject to G.S. 87-44.1 and G.S. 87-47, after receipt and evaluation of a renewal application from a licensee and the payment of the required fee. The application shall be upon a form provided by the Board and shall require such information as the Board may prescribe. Renewal applications and fees shall be due 30 days prior to the license expiration date. Upon failure to renew by the expiration date established by the Board, the license shall be automatically revoked. This license may be reinstated by the Board, subject to G.S. 87-44.1 and G.S. 87-47, upon payment of the license fee, an administrative fee of twenty-five dollars (\$25.00), and all fees for the lapsed period during which the person, partnership, firm, or corporation engaged in electrical contracting, and, further, upon the satisfaction of such experience requirements during the lapse as the Board may prescribe by rule. The Board may collect fees from applicants for examinations in an amount not to exceed one hundred twenty-five dollars (\$125.00), except the fee for a specially arranged examination shall not exceed two hundred dollars (\$200.00). In addition, the Board may collect an examination review fee, not to exceed twenty-five dollars (\$25.00), from failed examinees who apply for a supervised review of their failed examinations.

### **87-44.1. CONTINUING EDUCATION COURSES REQUIRED.**

Beginning July 1, 1991, the Board may require as prerequisite to the annual renewal of a license that every listed qualified individual complete continuing education courses in subjects relating to electrical contracting to assure the safe and proper installation of electrical work and equipment in order to protect the life, health, and property of the public. The listed qualified individual shall complete, during the 12 months immediately preceding license renewal, a specific number of hours of continuing education courses approved by the Board prior to enrollment. The Board shall not require more than 10 hours of continuing education courses per 12 months and such continuing education courses shall include those taught at a community college as approved by the Board. The listed qualified individual may accumulate and carry forward not more than two additional years of the annual continuing education requirement. Attendance at any course or courses of continuing education shall be certified to the Board on a form provided by the Board and shall be submitted at the time the licensee makes application to the Board for its license renewal and payment of its license renewal fee. This continuing education requirement may be waived by the Board in cases of certified illness or undue hardship as provided for in the Rules of the Board.

**87-44.2. LICENSING OF NONRESIDENTS.**

- (a) Definitions. -- The following definitions apply in this section:
  - 1) Delinquent income tax debt. -- The amount of income tax due as stated in a final notice of assessment issued to a taxpayer by the Secretary of Revenue when the taxpayer no longer has the right to contest the amount.
  - 2) Foreign corporation. -- Defined in G.S. 55-1-40.
  - 3) Foreign entity. -- A foreign corporation, a foreign limited liability company, or a foreign partnership.
  - 4) Foreign limited liability company. -- Defined in G.S. 57D-1-03.
  - 5) Foreign partnership. -- Either of the following that does not have a permanent place of business in this State:
    - a. A foreign limited partnership as defined in G.S. 59-102.
    - b. A general partnership formed under the laws of a jurisdiction other than this State.
- (b) Licensing. -- The Board shall not issue a license for a foreign corporation unless the corporation has obtained a certificate of authority from the Secretary of Revenue pursuant to Article 15 of Chapter 55 of the General Statutes. The Board shall not issue a license for a foreign limited liability company unless the company has obtained a certificate of authority from the Secretary of State pursuant to Article 7 of Chapter 57D of the General Statutes.
- (c) Information. -- Upon request, the Board shall provide the Secretary of Revenue on an annual basis the name, address, and tax identification number of every nonresident individual and every foreign entity licensed by the Board. The information shall be provided in the format required by the Secretary of Revenue.
- (d) Delinquents. -- If the Secretary of Revenue determines that any nonresident individual or foreign corporation licensed by the Board, a member of any foreign limited liability company licensed by the Board, or a partner in any foreign limited liability company licensed by the Board, or a partner in any foreign partnership licensed by the Board, owes a delinquent income tax debt, the Secretary of Revenue may notify the Board of these nonresident individuals and foreign entities and instruct the Board not to renew their licenses. The Board shall not renew the license of such a nonresidential individual or foreign entity identified by the Secretary of Revenue unless the Board receives a written statement from the Secretary that the debt either has been paid or is being paid pursuant to an installment agreement.

**87-45. FUNDS.**

The fees collected for examinations and licenses under this Article shall be used for the expenses of the State Board of Examiners of Electrical Contractors in carrying out the provisions of this Article. No expenses of the Board or compensation of any member or employee of the Board shall be payable out of the treasury of the State of North Carolina; and neither the Board nor any member or employee thereof shall have any power or authority to make or incur any expense, debt, or other financial obligation binding upon the State of North Carolina. Any funds remaining in the hands of the secretary-treasurer to the credit of the Board after all expenses of the Board for the current fiscal year have been fully provided for shall be paid over to the North Carolina Engineering Foundation, Inc., for the benefit of the electrical engineering department of the Greater University of North Carolina. Provided, however, the Board shall have the right to maintain an amount, the cumulative total of which shall not exceed twenty percent (20%) of gross receipts for the previous fiscal year of its operation as a maximum contingency or emergency fund.

**87-46. RESPONSIBILITY OF LICENSEE; NONLIABILITY OF BOARD.**

Nothing in this Article shall relieve the holder or holders of licenses issued under the provisions hereof from complying with the building or electrical codes or statutes or ordinances of the State of North Carolina, or of any county or municipality thereof now in force or hereafter enacted. Nothing in this Article shall be construed as relieving the holder of any license issued hereunder from responsibility or liability for negligent acts on the part of such holder in connection with electrical contracting work; nor shall the State Board of Examiners of Electrical Contractors be accountable in damages, or otherwise, for the negligent act or acts of any holder of such license.

**87-47. PENALTIES IMPOSED BY BOARD; ENFORCEMENT PROCEDURES.**

- (a1) The following activities are prohibited:
  - 1) Offering to engage or engaging in electrical contracting without being licensed.
  - 2) Selling, transferring, or assigning a license, regardless of whether for a fee.
  - 3) Aiding or abetting an unlicensed person, partnership, firm, or corporation to offer to engage or to engage in electrical contracting.
  - 4) Being convicted of a crime involving fraud or moral turpitude.
  - 5) Engaging in fraud or misrepresentation to obtain a certification, obtain or renew a license, or practice electrical contracting.
  - 6) Engaging in false or misleading advertising.
  - 7) Engaging in malpractice, unethical conduct, fraud, deceit, gross negligence, gross incompetence, or gross misconduct in the practice of electrical contracting.
- (a2) The Board may administer one or more of the following penalties if the applicant, licensee, or qualified individual has engaged in any activity prohibited under subsection (a1) of this section:
  - 1) Reprimand.
  - 2) Suspension from practice for a period not to exceed 12 months.
  - 3) Revocation of the right to serve as a listed qualified individual on any license issued by the Board.
  - 4) Revocation of license.



- 5) Probationary revocation of license or the right to serve as a listed qualified individual on any license issued by the Board, upon conditions set by the Board as the case warrants, and revocation upon failure to comply with the conditions.
  - 6) Revocation of certification.
  - 7) Refusal to certify an applicant or a qualified individual.
  - 8) Refusal to issue a license to an applicant.
  - 9) Refusal to renew a license.
- (a3) In addition to administering a penalty under subsection (a2) of this section, the Board may assess a civil penalty of not more than one thousand dollars (\$1,000) against a licensee or a qualified individual who has engaged in an activity prohibited under subsection (a1) of this section or has violated another provision of this Article or a rule adopted by the Board. Civil penalties collected under this subsection shall be deposited in the General Fund of North Carolina as nontax revenue. In determining the amount of a civil penalty, the Board shall consider:
- 1) The degree and extent of harm to the public safety or to property, or the potential for harm.
  - 2) The duration and gravity of the violation.
  - 3) Whether the violation was committed willfully or intentionally or reflects a continuing pattern.
  - 4) Whether the violation involved elements of fraud or deception either to the public or to the Board, or both.
  - 5) The violator's prior disciplinary record with the Board.
  - 6) Whether and the extent to which the violator profited by the violation.
- (a4) Any person, including the Board and its staff on their own initiative, may prefer charges pursuant to this section, and such charges must be submitted in writing to the Board. The Board may, without a hearing, dismiss charges as unfounded or trivial. The Board may issue a notice of violation based on the charges, to be served by a member of the Board's staff or in accordance with Rule 4 of the Rules of Civil Procedure, against any person, partnership, firm, or corporation for engaging in an activity prohibited under subsection (a1) of this section or for a violation of the provisions of this Article or any rule adopted by the Board. The person or other entity to whom the notice of violation is issued may request a hearing by notifying the Board in writing within 20 days after being served with the notice of violation. Hearings shall be conducted by the Board or an administrative law judge pursuant to Article 3A of Chapter 150B of the General Statutes. In conducting hearings, the Board may remove the hearings to any county in which the offense, or any part thereof, was committed if in the opinion of the Board the ends of justice or the convenience of witnesses require such removal.
- (a5) If the person or other entity does not request a hearing under subsection (a4) of this section, the Board shall enter a final decision and may impose penalties against the person or other entity. If the person or other entity is not a licensee or a qualified individual, the Board may impose penalties under subsection (a2) of this section. If the person or other entity is a licensee or a qualified individual, the Board may impose penalties under subsection (a2) of this section, subsection (a3) of this section, or both.
- (b) The Board shall adopt and publish rules, in accordance with Chapter 150B of the General Statutes and consistent with the provisions of this Article, governing the matters contained in this section.
- (c) The Board shall establish and maintain a system whereby detailed records are kept regarding charges and notices of violation pursuant to this section. This record shall include, for each person, partnership, firm, and corporation charged or notified of a violation, the date and nature of each charge or notice of violation, investigatory action taken by the Board, any findings by the Board, and the disposition of the matter.
- (d) The Board may reinstate a qualified individual's certification and may reinstate a license after having revoked it, provided that one year has elapsed from revocation until reinstatement and that the vote of the Board for reinstatement is by a majority of its members. The Board shall immediately notify the Secretary of State and the electrical inspectors within the licensee's county of residence upon the revocation of a license or the reissuance of a license which had been revoked.
- (e) In any case in which the Board is entitled to convene a hearing to consider imposing any penalty provided for in subsection (a2) or (a3) of this section, the Board may accept an offer in compromise of the charge, whereby the accused shall pay to the Board a penalty of not more than one thousand dollars (\$1,000). Penalties collected by the Board under this subsection shall be deposited in the General Fund of North Carolina as nontax revenue.

**87-48. PENALTY FOR VIOLATION OF ARTICLE; POWERS OF BOARD TO ENJOIN VIOLATION.**

- (a) Any person, partnership, firm, or corporation who shall violate any of the provisions of this Article or any rule of the Board adopted pursuant to this Article or who shall engage or offer to engage in the business of installing, maintaining, altering, or repairing within the State of North Carolina any electric wiring, devices, appliances, or equipment without first having obtained a license under the provisions of this Article shall be guilty of a Class 2 misdemeanor.
- (b) Whenever it shall appear to the State Board of Examiners of Electrical Contractors that any person, partnership, firm, or corporation has violated, is violating, or threatens to violate any provisions of this Article, the Board may apply to the courts of the State for a restraining order and injunction to restrain such practices. If upon such application the court finds that any provision of this Article is being violated, or a violation thereof is threatened, the court shall issue an order restraining and enjoining such violations, and such relief may be granted regardless of whether criminal prosecution is instituted under the provisions of this Article. The venue for actions brought under this subsection shall be the superior court of any county in which such acts are alleged to have been committed or in the county where the defendants in such action reside.

**87-49. NO EXAMINATION REQUIRED OF LICENSED CONTRACTORS.**

Any person, firm or corporation licensed in this State as a Class II electrical contractor on the effective date of this Article shall be entitled to be licensed, without examination, in the limited classification upon payment of the required fee and may be licensed in the intermediate or in the unlimited



classification without written examination upon satisfactory proof to the Board that such applicant is in fact qualified for such classification. Any person, firm or corporation licensed in this State as a Class I electrical contractor on the effective date of this Article shall be entitled to be licensed without examination in the limited, intermediate, or unlimited classification upon payment of the required fee. Provided, that any person who has been once duly licensed by the Board, whose license has expired solely because of failure to apply for renewal, may apply and have a license issued under the provisions of this section if within a period of 12 months preceding such issuance the applicant shall have been primarily actively engaged as an electrical contractor or in an occupation which in the judgment of the Board is similar or equivalent to that of an electrical contractor.

**87-50. RECIPROCIITY.**

To the extent that other states which provide for the licensing of electrical contractors provide for similar action, the Board may grant licenses of the same or equivalent classification to electrical contractors licensed by other states without written examination upon satisfactory proof furnished to the Board that the qualifications of such applicants are equal to the qualifications of holders of similar licenses in North Carolina and upon payment of the required fee.

**87-50.1. PUBLIC AWARENESS PROGRAM.**

The Board shall establish and implement a public awareness program to inform the general public of the purpose and function of the Board.

**87-51. SEVERABILITY OF PROVISIONS.**

If any provision of this Article or the application thereof to any person or circumstances is for any reason held invalid, such invalidity shall not affect other provisions or applications of the Article which can be given effect without the invalid provision or application, and to this end the provisions of this Article are declared to be severable.

**BOARD'S RULES FOR THE IMPLEMENTATION OF THE ELECTRICAL CONTRACTING LICENSING ACTS****TITLE 21 NCAC - CHAPTER 18B****SECTION .0100 - GENERAL PROVISIONS****.0101 PRINCIPAL OFFICE: MAILING ADDRESS: OFFICE HOURS**

The State Board of Examiners of Electrical Contractors has designated 505 N. Greenfield Parkway, Suite 100, Garner, NC 27529, as its principal office and mailing address. Its regular office business hours are posted on the Boards website, [www.ncbeec.org](http://www.ncbeec.org).

*History Note: Authority G.S. 87-39; 87-42; Eff. October 1, 1988. Amended Eff. July 1, 20223; July 1, 2016; January 1, 2006.*

**.0102 REFERENCE TO STATE BUILDING AND ELEVATOR CODES**

(a) Pursuant to G.S. 150B-14(c), the North Carolina State Building Code, Volume IV Electrical, and the National Electrical Code, NFPA 70, are incorporated by reference. Whenever a reference is made in this Subchapter to one of these codes, it means the current edition and any amendments thereto. The term "National Electrical Code" when used in these rules includes both codes incorporated in this paragraph.

(b) Pursuant to G.S. 150B-21.6, the North Carolina codes and standards for elevators, dumbwaiters, escalators, moving walks and personnel hoists, administered by the North Carolina Department of Labor, and codified as 13 NCAC 15 .0200, are incorporated by reference. Whenever a reference is made in this Subchapter to these codes and standards, it means the current edition and amendments thereto.

*History Note: Authority G.S. 87-39; 87-42; 95-11(e); 143-138; Eff. October 1, 1988. Amended Eff. July 1, 2011.*

**.0103 ANNUAL REPORTS**

Annual Reports. The Board shall make timely filing of all reports required by G.S. 93B-2. In case of the untimely filing of a report, then pursuant to G.S. 93B-2(d), the Board shall hold in escrow any fees tendered between the filing deadline and the filing date. Issuance of licenses, renewals and application processing shall continue during any interval created by the untimely filing of a report required by G.S.93B-2.

*History Note: Authority G.S. 87-39; 87-40; 87-42; 93B-2; Eff. October 1, 1988. Amended Eff. July 1, 2011; February 1, 1996; February 1, 1990.*

**.0104 AUTHORIZED LEGAL ACTION BY STAFF**

(a) The following members of the Board's staff are authorized to act on behalf of the Board in criminal and civil actions brought under the provisions of G.S. 87-48:

- 1) the Board's executive director; and
- 2) the Board's field representatives/investigators.

(b) The staff members set out in paragraph (a) of this rule are authorized to sign affidavits as to the content of Board records, execute or verify civil complaints in the name of the Board, sign criminal warrants with respect to violations of G.S.87-48, testify in court or in other proceedings and to perform all other acts as may be required in criminal and civil actions related to G.S. 87-48.

*History Note: Authority G.S. 87-40; 87-42; 87-43; Eff. October 1, 1988. Amended Eff. February 1, 2006; April 1, 1993.*

**.0105 BOARD RECORDS**

The records of the Board shall be maintained at the Board office and shall be available for public inspection, in accordance with G.S. 132, during regular office business hours.

*History Note: Authority G.S. 87-42; 87-47; 132-1; Eff. October 1, 1988. Amended Eff. February 1, 1995.*

**.0106 JOINT RESOLUTION AND AGREEMENTS (Repealed )**

*History Note: Authority G.S. 87-39; 87-42; Eff. October 1, 1988. Repealed Eff. July 1, 2011*

**.0107 PROCESSING FEE FOR SUBMITTAL OF BAD CHECK**

(a) Any person, firm or corporation submitting to the Board a check which is subsequently returned to the Board because of insufficient funds in or no account at a bank shall be charged the maximum processing fee allowed by G.S. 25-3-506 for processing such check.

(b) Until such time as the payor of such bad check has made the check good and paid the prescribed processing fee, the payor shall not be eligible to take an examination, review an examination, obtain a license, or have a license renewed.

(c) Any license which has been issued based on the payment of a check which is subsequently returned to the Board for reasons stated herein shall be declared invalid until such time as the payor has made the check good and paid the prescribed processing fee.

(d) Payment to the Board for making good such bad check and for the prescribed processing fee may be made in the form of cash, cashier's check, or money order.

(e) All examination, examination review, license and license renewal applications provided by the Board shall contain information in a conspicuous place thereon clearly advising the applicant of the foregoing bad check processing fee.

*History Note: Authority G.S. 25-3-506; 87-42; Eff. October 1, 1988. Amended Eff. May 1, 1998.*



**.0108 PETITION FOR RULE-MAKING PROCEDURES**

- (a) Any person wishing to request the Board to adopt, amend, or repeal a rule shall file a petition with the Board pursuant to G.S. 150B-20, by mail or personal delivery. The petition shall be signed by the petitioner and shall include the petitioner's address.
- (b) There is no form required for the petition.
- (c) The Board shall grant the petition if it finds the requested rule change would comply with the requirements of law and, if so, it would likely serve the public interest. The Board may request additional information from the petitioner and may contact interested persons or persons likely to be affected by the proposal and request their comments in order to obtain information upon which to base the determination of public interest. Before granting or denying the petition, the Board shall consider the contents of the petition and any other information filed with or obtained by the Board.  
*History Note: Authority G.S. 87-42; 150B-20; Eff. October 1, 1988. Amended Eff. March 1, 1999.*

**.0109 DECLARATORY RULING PROCEDURES**

- (a) All requests for declaratory rulings shall be written and mailed to the Board at the Board's address.
- (b) Each request for a declaratory ruling must include the following information:
  - 1) the name and address of the person requesting the ruling;
  - 2) the statute or rule to which the request relates;
  - 3) a concise statement of the manner in which the requesting person is aggrieved by the rule or statute or its potential application to him;
  - 4) a statement whether an oral hearing is desired and, if so, the reason therefor.
- (c) Upon receipt of a request for a declaratory ruling, the Board shall determine whether a ruling is appropriate under the facts stated.
- (d) The Board shall proceed to issue a declaratory ruling when the person requesting the ruling shows that, with regard to the facts presented:
  - 1) the rule or statute in question is unclear on its face;
  - 2) circumstances are so changed since the adoption of a rule that a declaratory ruling is warranted;
  - 3) the factors specified in the request were not given appropriate consideration by the Board at the time the rule was adopted;
  - 4) the rule or statute is unclear in its application to the requesting person's facts; or
  - 5) a fair question exists regarding the validity of the rule because of:
    - (A) an absence of authority for the Board's adoption of the rule; or
    - (B) irregularities in the Board's rule-making proceedings.
- (e) When the Board determines for good cause that the issuance of a declaratory ruling is undesirable, the Board shall notify, in writing, the person requesting the ruling, stating the reasons for the denial of the request. The Board will ordinarily decline to issue a declaratory ruling when:
  - 1) there has been a similar controlling factual determination made by the Board;
  - 2) the rule-making record shows that the factual issues raised by the request were specifically considered prior to adoption of the rule; or
  - 3) the subject matter of the request is involved in pending litigation in any state or federal court in North Carolina.
- (f) Prior to issuing a declaratory ruling, the Board may give notice of the declaratory proceedings to any persons it deems appropriate and may direct those fact-finding proceedings appropriate to the circumstances of the particular request be conducted by the Board. The proceedings may consist of written submissions, an oral hearing, or other appropriate procedures.
- (g) If the Board finds evidence that the factors listed in Subdivisions (d)(1), (2), or (3) of this Rule exist or potentially exist beyond the specific facts presented in a particular petition for declaratory ruling, the Board shall consider rule-making proceedings on the rule.
- (h) A record of each declaratory ruling and the procedures conducted therefore will be maintained by the Board at least until:
  - 1) the statute or rule interpreted by the declaratory ruling is amended, altered, or repealed;
  - 2) the Board prospectively changes the declaratory ruling for good reason;
  - 3) any court sets aside the ruling in litigation between the Board and the party requesting the ruling; or
  - 4) any court of the Appellate Division of the General Court of Justice construes the statute or rule which is the subject of the declaratory ruling in a manner plainly irreconcilable with the declaratory ruling.
- (i) The record will contain:
  - 1) the request for a declaratory ruling;
  - 2) all written submissions filed in the request, whether filed by the person requesting the ruling or by any other person;
  - 3) a record or summary of oral presentations, if any; and
  - 4) a copy of the declaratory ruling.

*History Note: Authority G.S. 87-42; 150B-4; Eff. October 1, 1988.*

**.0110 PRODUCTION OF PUBLIC RECORDS**

- (a) Records of current license status are available without charge on the Board website, [www.ncbeec.org](http://www.ncbeec.org).
- (b) Production of license history or verification of license of licensees or qualified individuals is available at a cost of \$25.00 for each report.  
*History Note: Authority G.S. 87-42, G.S. 87-44, G.S. 93B-3, G.S. 150B-19; Eff. October 1, 2017.*



**SECTION .0200 – EXAMINATIONS****.0201 REQUIREMENTS FOR ALL EXAMINATION APPLICANTS**

- (a) To take an examination in any electrical contracting license classification, the applicant must:
- 1) be at least 18 years of age;
  - 2) submit the required duly filed application as defined in Rule .0210;
  - 3) submit with the application written statements from at least two persons attesting to the applicant's good character; and
  - 4) meet any other requirements set out in Paragraph (b) of this Rule.
- (b) Examination applicants must meet the following requirements for the specified license classifications:
- 1) **Limited classification.** An applicant must have at least 3,000 hours of experience, as defined in Rule .0202 of this Section, of which at least 2,000 hours shall be primary experience. The balance of experience may be primary, secondary or both.
  - 2) **Intermediate classification.** An applicant must have at least 5,750 hours of experience, as defined in Rule .0202 of this Section, of which at least 5,000 hours shall be primary experience. The balance of experience may be primary, secondary or both.
  - 3) **Unlimited classification.** An applicant must:
    - A) have at least 9,000 hours of experience, as defined in Rule .0202 of this Section, of which at least 8,000 hours shall be primary experience. The balance of experience may be primary, secondary or both, and
    - B) submit with the application written statements from at least two persons, who are knowledgeable of the applicant's electrical experience, attesting to the applicant's ability to supervise and direct all electrical wiring or electrical installation work done by an electrical contracting business in the unlimited classification.
  - 4) **Single family detached residential dwelling (SP-SFD) classification.** An applicant must have at least 3,000 hours of experience, as defined in Rule .0202 of this Section, of which at least 2,000 hours shall be primary experience. The balance of experience may be primary, secondary or both.
  - 5) **Special restricted fire alarm/low voltage (FALV) classification.** An applicant must have at least 3,000 hours of experience, as defined in Rule .0202 of this Section, of which at least 2,000 hours shall be primary experience. The balance of experience may be primary, secondary or both. An applicant in this classification may also receive creditable experience for service in any of the capacities listed in Rule .0202 that the applicant gained in the low voltage field.
  - 6) **Special restricted elevator (SP-EL) classification.** An applicant must:
    - A) have at least 3,000 hours of experience, as defined in Rule .0202 of this Section, of which at least 2,000 hours shall be primary experience. The balance of experience may be primary, secondary or both. An applicant in this classification may also receive creditable experience for service in any of the capacities listed in Rule .0202 that the applicant gained in the elevator field, and
    - B) include on the application information verifying that the applicant is primarily engaged in or is regularly employed by and will be the listed qualified individual, for a firm that is primarily engaged in, a lawful elevator business in this State.
  - 7) **Special restricted plumbing and heating (SP-PH) classification.** An applicant must:
    - A) have at least 3,000 hours of experience, as defined in Rule .0202 of this Section, of which at least 2,000 hours shall be primary experience. The balance of experience may be primary, secondary or both. An applicant in this classification may also receive creditable experience for service in any of the capacities listed in Rule .0202 that the applicant gained in the plumbing, heating, or air conditioning field, and
    - B) include on the application information verifying that the applicant is primarily engaged in or is regularly employed by and will be the listed qualified individual, for a firm that is primarily engaged in, a lawful plumbing, heating, or air conditioning business in this State.
  - 8) **Special restricted ground water pump (SP-WP) classification.** An applicant must:
    - A) have at least 3,000 hours of experience, as defined in Rule .0202 of this Section, of which at least 2,000 hours shall be primary experience. The balance of experience may be primary, secondary or both. An applicant in this classification may also receive creditable experience for service in any of the capacities listed in Rule .0202 that applicant gained in the ground water pump field, and
    - B) include on the application information verifying that the applicant is primarily engaged in or is regularly employed by and will be the listed qualified individual for a firm that is primarily engaged in, a lawful ground water pump business in this State.
  - 9) **Special restricted electric sign (SP-ES) classification.** An applicant must:
    - A) have at least 3,000 hours of experience, as defined in Rule .0202 of this Section, of which at least 2,000 hours shall be primary experience. The balance of experience may be primary, secondary or both. An applicant in this classification may also receive creditable experience in any of the capacities listed in Rule .0202 that the applicant gained in the electric sign field, and
    - B) include on the application information verifying that the applicant is primarily engaged in or is regularly employed by and will be the listed qualified individual for a firm that is primarily engaged in, a lawful electric sign business in this State.
  - 10) **Special restricted swimming pool (SP-SP) classification.** An applicant must:
    - A) have at least 3,000 hours of experience, as defined in Rule .0202 of this Section, of which at least 2,000 hours shall be primary experience. The balance of experience may be primary, secondary or both. An applicant in this classification may also receive creditable experience for service in any of the capacities listed in Rule .0202 that the applicant gained in the swimming pool field, and
    - B) include on the application information verifying that the applicant is primarily engaged in or is regularly employed by and will be the listed qualified individual for a firm that is primarily engaged in, a lawful swimming pool business in this State.

*History Note: Authority G.S. 87-42; 87-43.3; 87-43.4; 87-44; Eff. October 1, 1988. Amended Eff. October 1, 2022; October 1, 2017; January 1, 2010; March 1, 1999; February 1, 1990.*

**.0202 EXPERIENCE**

(a) **Primary.** As used in this Chapter, **primary experience means working experience gained by the applicant while engaged directly in the installation of electrical wiring and equipment governed by the National Electrical Code or work activities directly related thereto.** Examples of the capacity in which a person may work in gaining primary experience and the percentages for creditable primary experience are as follows:

PRIMARY CAPACITY EXAMPLES	% OF HOURS ACCEPTED
1) Journeyman electrician or electrician mechanic, both meaning the same; .....	100
2) Electrical foreman; .....	100
3) Electrical general foreman;.....	100
4) Electrical superintendent;.....	100
5) Electrical general superintendent;.....	100
6) Estimator for licensed electrical contractor;.....	100
7) Electrical inspector recognized as such by the State Department of Insurance;.....	100
8) Time spent by a professional engineer who is responsible for follow-up project supervision, beyond the point of delivery, in electrical engineering, design consulting;.....	100
9) Full-time instructor teaching National Electrical Code, NFPA 72 and related electrical courses at a college, university, community college, technical institute, high school or vocational school;.....	80
10) Maintenance journeyman electrician or electrician mechanic employed in a full-time electrical maintenance department;.....	100
11) Time actually spent in electrical maintenance by a maintenance journeyman electrician or electrician mechanic regularly employed in other than a full-time electrical maintenance department;.....	100
12) Military person holding an electrician rating or rank of at least E-4 who is engaged in land-based electrical installations similar or equivalent to work performed by an electrical contractor;.....	100
13) Time actually spent in part-time or incidental work in any primary experience category;.....	100
14) Time actually spent installing or maintaining fire alarm/low voltage systems;.....	100
15) Time as a holder of NICET certification on NFPA 72 Level I, II, III or IV applicable to Fire Alarm and Low Voltage only.....	100

In calculating accumulative primary experience, **a total of 2,000 hours shall equal one full-time creditable year.** The total number of creditable years shall be calculated by dividing the total hours of primary experience by 2,000. *Example: Applicant has worked in primary capacity for a total of 7,200 hours of primary experience.  $7,200 / 2,000 = 3.6$  years creditable primary work experience.*

(b) **Secondary.** As used in this Chapter, **secondary experience means working experience gained while engaged in work or training that is related to the installation of electrical wiring and equipment governed by the National Electrical Code.** Examples of the type of work or training in which a person may engage to gain creditable secondary experience and the percentages for creditable secondary experience are as follows:

SECONDARY CAPACITY EXAMPLES	% OF HOURS ACCEPTED
1) Apprentice electrician training in an apprentice program approved by the NC Community College System;.....	100
2) Time spent as an apprentice electrician or helper other than as described in subparagraphs (1) and (3) of this paragraph;.....	80
3) Time actually spent in electrical maintenance by a maintenance apprentice or electrician helper regularly employed in other than a full-time electrical maintenance department;.....	80
4) Student satisfactorily completing National Electrical Code and related electrical courses at a college, university, community college, technical institute, high school, or vocational school;.....	50
5) Time spent by a professional engineer who is not responsible for follow-up project supervision, beyond the point of delivery, in electrical engineering, design, or consulting;.....	50
6) Electrical construction design under the supervision of a professional engineer;.....	50
7) Sales representative for an electrical wholesaler, distributor, or manufacturer;.....	20
8) Appliance service and repair;.....	20
9) Electric utility lineman; and.....	10
10) Electric utility serviceman.....	20

In calculating accumulative secondary experience, **a total of 2,000 hours shall equal one full-time creditable year.** The total number of creditable years shall be calculated by applying the percentage for creditable secondary experience and dividing the remainder hours by 2,000. *Example: Applicant has 1,000 hours of work experience as a helper or regular apprentice and 2,200 hours of experience while enrolled in an approved apprentice training program:  $1,000$  hours at 80 percent = 800 hours secondary experience;  $2,200$  hours at 100 percent = 2,200 hours secondary experience;  $800 + 2,200 / 2,000 = 1.5$  years creditable secondary experience*

(c) **Other Experience.** The Board shall approve other experience that it finds to be equivalent or similar to the primary or secondary experience defined in this Rule.

*History Note: Authority G.S. 87-42; 87-43.3; 87-43.4; Eff. October 1, 1988. Amended Eff. October 1, 2017; January 1, 2010; March 1, 1999.*



**.0203 EXAMINATION SCOPE**

- (a) General. In addition to the examination subjects specified in G.S. 87-42, qualifying examinations for each license classification shall include permit and inspection requirements, business practices and the North Carolina statutes and rules applicable to electrical contracting.
- (b) Variation in Scope. The examinations for each license classification shall be based on a level of technical and practical knowledge concerning the safe and proper installation of electrical work and equipment that corresponds to the electrical contracting work authorized under each license classification.

*History Note: Authority G.S. 87-42; 87-43.3; 87-43.4; Eff. October 1, 1988. Amended Eff. March 1, 1999; April 1, 1993.*

**.0204 EXAMINATIONS**

- (a) All qualifying examinations administered by the Board for each license classification shall be written or computer-based examinations and must be taken personally by the approved applicant after the applicant has met the requirement for examination contained in the rules in this subchapter.
- (b) Upon approval of an applicant pursuant to these Rules, the Board shall provide the applicant a notice of examination eligibility that is valid for a period of three months and for a single administration of the qualifying examination. Upon receipt of a notice of examination eligibility from the Board, the applicant shall schedule the examination by contacting the Board or the authorized testing service. The applicant shall be scheduled for the examination by the Board and the Board or authorized testing service will confirm the date, time, and place.
- (c) A minimum grade of 70 out of a possible score of 100 is required in order to pass any qualifying examination administered by the Board.

*History Note: Authority G.S. 87-42; 87-43.3; 87-43.4; 93B-8; Eff. October 1, 1988. Temp. Amended Eff. August 31, 2001. Amended Eff. October 1, 2017; July 1, 2011; January 1, 2006; July 18, 2002.*

**.0205 MINIMUM PASSING GRADE (Repealed)**

*History Note: Authority G.S. 87-42; 87-43.3; 87-43.4; 87-44; Eff. October 1, 1988. Repealed Eff. July 1, 2011.*

**.0206 REGULAR EXAMINATIONS (Repealed)**

*History Note: Authority G.S. 87-42; 87-43.3; 87-43.4; 87-44; Eff. October 1, 1988. Repealed Eff. July 1, 2011.*

**.0207 APPLICATION FOR REGULAR EXAMINATIONS (Repealed)**

*History Note: Authority G.S. 87-42; 87-43.3; 87-43.4; 87-44; Eff. October 1, 1988. Repealed Eff. July 1, 2011.*

**.0208 SPECIALLY ARRANGED EXAMINATIONS (Repealed )**

*History Note: Authority G.S. 87-42; 87-43.3; 87-43.4; 87-44; Eff. October 1, 1988. Repealed Eff. July 1, 2011.*

**.0209 FEES**

- (a) The application and exam fee for qualifying examinations shall be One Hundred Twenty-Five Dollars (\$125.00) for all classifications.
- (b) The fee for a review of a failed examination is twenty-five dollars (\$25.00). All reviews are supervised by the Board or staff.
- (c) The examination fees for examinations in all classifications and the fees for examination reviews shall be in the form of check, money order, or credit card made payable to the Board and shall accompany the respective applications when filed with the Board.
- (d) Examination fees received with applications filed for qualifying examinations shall be retained by the Board unless:
  - 1) an application is not filed as prescribed in Rule .0210 of this Section, in which case the examination fee of sixty dollars (\$60.00) shall be returned and application shall be returned; or
  - 2) the applicant does not take the examination during the examination period for which application was made, files a written request for a refund setting out extenuating circumstance and the Board finds extenuating circumstances.
- (e) Examination review fees are non-refundable unless the applicant does not take the review, files a written request for a refund, setting out extenuating circumstance and the Board finds extenuating circumstances.
- (f) Any fee retained by the Board shall not be creditable toward any future examination fee or examination review.
- (g) Extenuating circumstances for the purposes of Paragraphs (d)(2) and (e) of this Rule shall be the applicant's illness, bodily injury or death, or death of the applicant's spouse, child, parent, or sibling, or a breakdown of the applicant's transportation to the designated site of the examination or examination review.

*History Note: Authority G.S. 87-42; 87-43.3; 87-43.4; 87-44; Eff. October 1, 1988. Temp. Amended Eff. June 30, 2000; August 31, 2001. Amended Eff. July 1, 2023; July 1, 2016; February 2, 2016; July 1, 2011; January 1, 2008; December 4, 2002; May 1, 1998; July 1, 1989.*

**.0210 APPLICATIONS DULY FILED**

Examinations applications shall be considered as duly filed when the applicant has filed an application with the Board, on a form provided by the Board, together with the examination fee as prescribed in Rule .0209 of this Section and information sufficient to meet the minimum examination requirements applicable to the classification involved. By filing an application with the Board, an applicant authorizes the Board or the Board's staff to verify, in any manner the Board or staff deems necessary and appropriate, the information submitted on or in support of his application. The Board or staff shall determine whether applications are duly filed, process all applications, and return all applications not duly filed.

*History Note: Authority G.S. 87-42; 87-43.3; 87-43.4; 87-44; Eff. October 1, 1988. Temp. Amended Eff. August 31, 2001. Amended Eff. July 1, 2011; July 18, 2002.*



**.0211 WAITING PERIOD BETWEEN EXAMINATIONS**

- (a) A person who fails a qualifying examination must wait three months from the date of the failed examination before being eligible to take another examination in the same classification.
- (b) A person shall be considered a new applicant each time he or she applies to take an examination and must file an application on the standard application form and pay the required application fee and examination fee.

*History Note: Authority G.S. 87-42; 87-43.3; 87-43.4; Eff. October 1, 1988. Amended Eff. July 1, 2016; July 1, 2011; January 1, 2006.*

**SECTION .0300 - DEFINITIONS AND EXPLANATIONS OF TERMS APPLICABLE TO LICENSING**

**.0301 LISTED QUALIFIED INDIVIDUAL**

A listed qualified individual cannot be “regularly on active duty”, as the term is used in G.S. 87-43, during the hours when he has committed himself to work for an employer other than the employers on whose license, he is the listed qualified individual. Therefore, no electrical contracting work can be done under a license during the hours its listed qualified individual has committed himself to duty as an employee in other employment.

*History Note: Authority G.S. 87-42; 87-43; Eff. October 1, 1988. Amended Eff. February 1, 1990.*

**.0302 DRAWINGS**

Pursuant to an agreement between the Board and the North Carolina State Board for Professional Engineers and Land Surveyors, the following definitions and procedures shall apply to drawings:

- 1) Design Drawing. A design drawing indicates the total result to be achieved by an assembly of various systems. It is the creative work of a design professional, prepared with the use of special knowledge of the mathematical, physical, and engineering sciences in order to accomplish a specific function and bears the seal of the preparing design professional.
- 2) Shop Drawing. A shop drawing indicates the fabrication, assembly, installation, or erection of a system’s components. It is usually prepared by the manufacturer or installing contractor for the purpose of conveying to the mechanic the materials and construction sequencing procedures to be used in achieving the total result called for by the design drawings.
- 3) Drawings by Contractor. If design drawings are not required by any statute, the installation contractor may prepare preliminary drawings to illustrate his proposed installation. If design drawings are required by a statute for an installation, the contractor may prepare preliminary drawings to illustrate his proposed installation; provided his proposal contains specific provisions to assure the awarding authority that, if awarded the project, the services of a duly registered professional will be employed to prepare the required final design drawings for the installation proposed and that the installation will be constructed in accordance with such design drawings.

*History Note: Authority G.S. 87-39; 87-42; Eff. October 1, 1988.*

**.0303 ELECTRICAL INSTALLATION: PROJECT: PROJECT VALUE-LIMITATION**

For the purpose of implementing G.S. 87-43.3 pertaining to the limited and intermediate electrical contracting license classifications, the following provisions shall apply:

- 1) Electrical Installation. Electrical work is construed to be an electrical installation when the work is made or is to be made:
  - a) in or on a new building or structure;
  - b) in or on an addition to an existing building or structure;
  - c) in or on an existing building or structure, including electrical work in connection with lighting or power rewiring or with the addition or replacement of machines, equipment, or fixtures; or
  - d) in an area outside of buildings or structures, either overhead or underground or both.
- 2) Project. An electrical installation is construed to be a separate electrical contracting project if all the following conditions are met:
  - a) the installation is, or will be, separate and independently supplied by a separate service, feeder or feeder system; and
  - b) the installation is for:
    - i. an individual building or structure which is separated from other buildings or structures by a lot line or, if located on the same lot with other buildings or structures, is physically separated from such other buildings or structures by an open space or an area separation fire wall;
    - ii. an individual townhouse single-family dwelling unit constructed in a series or group of attached units with property lines separating such units;
    - iii. an individual tenant space in a mall-type shopping center;
    - iv. an addition to an existing building or structure;
    - v. an existing building or structure, including electrical work in connection with lighting or power rewiring or with the addition or replacement of machines, equipment, or fixtures; or
    - vi. an outdoor area either overhead or underground or both.
  - c) the negotiations or bidding procedures for the installation are carried out in a manner totally separate and apart from the negotiations or bidding procedures of any other electrical installation or part thereof;
  - d) except for new additions, alterations, repairs or changes to a pre-existing electrical installation, no electrical interconnection or relationship whatsoever will exist between the installation and any other electrical installation or part thereof;



- e) a separate permit is to be obtained for each individual building structure or outdoor area involved from the governmental agency having jurisdiction.

If a question is raised by a party at interest or if requested by the Board or Board's staff for any reason, the owner or the awarding authority or an agent of either furnishes to the Board, and to the inspections department having jurisdiction, a sworn affidavit confirming that each and every one of the conditions set forth in (2)(a) through (e) of this Rule are satisfied.

- 3) Relationship of Plans and Specifications to Definition of Project. Even though such electrical work may not fully comply with each and every condition set out in Subparagraph (2) of this Rule, the entire electrical work, wiring, devices, appliances, or equipment covered by one set of plans or specifications is construed to be a single electrical contracting project.
- 4) Project Value Limitation. In determining the value of a given electrical contracting project, the total known or reasonable estimated costs of all electrical wiring materials, equipment, fixtures, devices, and installation must be included in arriving at this value, regardless of who furnishes all or part of same, and regardless of the form or type of contract or subcontract involved. if the total cost of the wiring, materials, etc., including that furnished by others, plus the total cost of the installation involved, will be more than sixty thousand dollars (\$60,000) but not more than one hundred fifty thousand dollars (\$150,000), then only an electrical contractor holding either an intermediate or unlimited license will be eligible to submit a proposal or engage in the project.
  - a) if the total cost of the wiring, materials, etc., including that furnished by others, plus the total cost of the installation involved, will be more than sixty thousand dollars (\$60,000), then only an electrical contractor holding either an intermediate or unlimited license will be eligible to submit a proposal or engage in the project.
  - b) if the total cost of the wiring, materials, etc., including that furnished by others, plus the total cost of the installation involved, will exceed one hundred fifty thousand dollars (\$150,000), then only an electrical contractor holding an unlimited license will be eligible to submit a proposal or engage in the project.

If a given electrical contracting project is subdivided into two or more contracts or subcontracts for any reason, then the total value of the combined contracts or subcontracts which may be awarded to or accepted by any one licensee of the Board must be within the total project value in accordance with this Rule.

The Board's staff shall make a determination of what constitutes a project in any given situation, and any party at interest shall have the right to appeal any staff determination to the Board for a final binding decision.

*History Note: Authority G.S. 87-42; 87-43; Eff. October 1, 1988. Amended Eff. July 1, 2020; September 1, 2014; January 1, 2008; February 1, 1996; February 1, 1990.*

**.0304 POINT OF DELIVERY AND RELATED TERMS**

- (a) "Point of delivery" and other terms related thereto are defined as follows:
  - (1) Consumer's Premises. A "consumer's premises" is any publicly or privately owned building, structure, land or facility to which electric energy is being furnished.
  - (2) Consumer's Wiring. A "consumer's wiring" is the portion of a wiring system that is located at or on the consumer's premises and for which the consumer has full responsibility for ownership, operation, and maintenance. This wiring is considered to be beyond the point of delivery.
  - (3) Electric Power Supplier. An "electric power supplier" is a public utility company, a private utility company, an electric membership co-op, a municipal utility or any other entity that furnishes electric energy for private or public use.
  - (4) Electric Power Supplier's Wiring. An "electric power supplier's wiring" is the portion of a wiring system that is located either off, at, or on the consumer's premises and for which the electric supplier has full responsibility for ownership, operation and maintenance. This wiring is considered to be ahead of the point of delivery.
  - (5) Point of Delivery. The "point of delivery," as used in G.S. 87-43.1(1), is the point where an electric power supplier's wiring terminates in the supplier's delivery of electrical energy to a consumer's wiring at or on the consumer's premises.
  - (6) Service Point. The "service point" in a wiring system, defined in the National Electrical Code as the point of connection between the facilities of the serving utility and the premises wiring, is construed to be the same as the point of delivery.
- (b) Special Conditions. Where conditions of service or other circumstances require that a portion of an electric power supplier's owned, operated and maintained equipment, such as metering and load control equipment, be installed within the consumer's wiring, such installation shall be construed to be beyond the point of delivery, and the installation of such equipment is required to be made by a licensee of the Board. This provision does not prohibit an electric power supplier from installing its metering and load control equipment in the enclosures for such equipment or removing same from such enclosures.
- (c) Rulings. Where conditions of service or other circumstances are such that the definition of point of delivery and the related terms in this Rule are not strictly applicable, either in whole or in part, a special limited ruling will be issued by the Board on request of any party of interest.
- (d) Illustration. The point of delivery and service point in a wiring system and the application of the North Carolina Electrical Contracting Licensing Act are further defined in the following illustration:

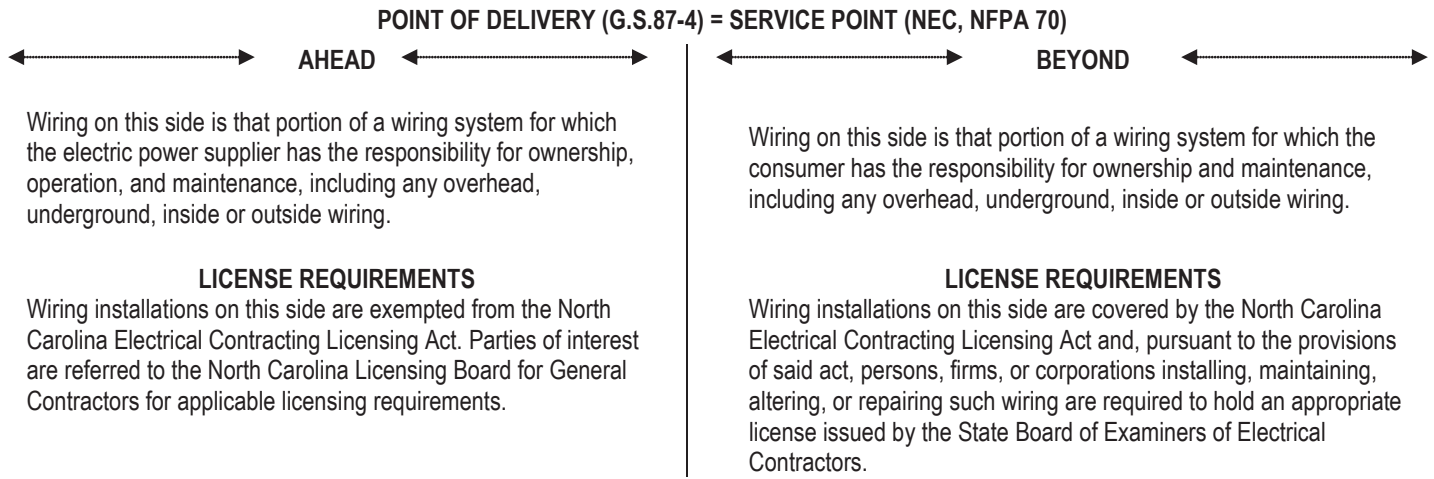

*History Note: Authority G.S. 87-39; 87-42; 87-43.1(1); Eff. October 1, 1988.*

**.0305 LICENSE REQUIREMENTS AND EXEMPTIONS**

- (a) Pursuant to G.S. 87-43.1(7), an electrical contractor’s license is not required for:
  - 1) the installation and servicing of electrical appliances or equipment which is being supplied through a cord connected by means of an attachment plug-in device to a suitable permanently installed receptacle; and
  - 2) the servicing of electrical appliances or equipment being supplied through wiring connected to a permanently installed junction box.
- (b) Unless exempted by a statute other than G.S. 87-43.1(7), an electrical contractor’s license is required for:
  - 1) the installation of the permanently installed receptacles to which cord-supplied electrical appliances or equipment are connected;
  - 2) the installation of the permanently installed junction boxes to which electrical appliances or equipment are connected; and
  - 3) any wiring connected to and supplied from the out-put side of any electrical appliances or equipment regardless of whether such appliances or equipment are supplied through a cord connected by means of an attachment plug-in device to a suitable permanently installed receptacle or are supplied through wiring connected to a permanently installed junction box.

*History Note: Authority G.S. 87-42; 87-43.1; Eff. October 1, 1988. Amended Eff. July 1, 2011.*

**.0306 BONA FIDE EMPLOYEE**

- (a) For the exemption for electrical work done as a bona fide employee of a licensee under G.S. 87-43.1(3), the following conditions must be met:
  - 1) The restrictions of the employing licensee’s license apply to any employee of the license.
  - 2) The employing licensee shall have control and direction of the details, methods and manner of performing the electrical work being done by the employee. The manner of payment, if any, to the person shall not be the sole determining factor concerning whether the person is an employee.
  - 3) The electrical work shall be performed under the supervision and direction of a listed qualified individual who is the employing licensee, or under the supervision and direction of a listed qualified individual regularly employed by the employing licensee.
- (b) The employing licensee, the employee, and every listed qualified individual of the licensee shall furnish any information the Board may require, including affidavits, to evaluate and determine a claim of employee exemption.
- (c) When the information furnished to the Board does not substantiate compliance with this Rule, the individual shall be deemed to be an independent contractor rather than an employee and shall be subject to G.S. Chapter 87, Article 4.

*History Note: Authority G.S. 87-42; Eff. October 1, 1988. Amended Eff. April 1, 1993.*

**.0307 CERTAIN ELECTRICAL WORK/MANUFACTURER/PREFABRICATED UNITS**

- (a) A manufacturer of prefabricated units is not required to be licensed by the Board to engage in installing, altering, or repairing the electric work, wiring, devices, appliances or equipment in or on its prefabricated units under either of the following conditions:
  - 1) during the time the prefabricated units are physically located at the actual place of manufacture; or
  - 2) after the prefabricated units have been removed from the actual place of manufacture if all of the following conditions are met:
    - A) the prefabricated units have been factory inspected, approved, and duly labeled by an independent certifying agency approved by the North Carolina Building Code Council; and
    - B) the work is specifically restricted to that part of the electrical installation covered under the approved independent certifying agency’s initial label and such work is performed by the manufacturer’s bona fide employees under the onsite direct personal supervision of the independent certifying agency’s official inspector and in cooperation with and approval by the local governmental inspection authority.



- (b) Except as specified in this Rule, this exemption from the North Carolina Electrical Contracting Licensing Act does not apply once a unit has been removed from the manufacturing facility and placed anywhere within the State of North Carolina, including sales lots, the property of purchasers and lessees, or any other place for any reason, either temporarily or permanently.
- (c) In order for a manufacturer to engage or offer to engage in the installation, alteration, maintenance or repair of any electric work, wiring, devices, appliances or equipment in connection with any unit, except as permitted in this Rule, the manufacturer must hold an active electrical contracting license issued by the Board.
- (d) Nothing in this Rule shall be construed to exempt any electrical work on any property from the North Carolina State Building Code requirements or from any local special construction rules or permit or inspection requirements.  
*History Note: Authority G.S. 87-42; 87-43; Eff. October 1, 1988.*

## **SECTION .0400 - LICENSING REQUIREMENTS**

### **.0401 LICENSE APPLICANTS: REQUIREMENTS FOR EACH CLASSIFICATION**

- (a) An applicant for an electrical contracting license in each of the license classifications shall:
  - 1) submit a completed application to the Board on a form provided by the Board for the license classification involved;
  - 2) submit the annual license fee for the license classification involved as prescribed in Rule .0404 of this Section; and
  - 3) furnish the name, signature and social security number of at least one person to serve as the listed qualified individual for the applicant's license.
- (b) Corporation, Partnership or Limited Liability Company. If the license applicant is a corporation, partnership or limited liability company, the application shall contain the names and titles of the officers, names of the partners or names of the members of the limited liability company, whichever is applicable.
- (c) Intermediate and Unlimited Classifications. License applicants in the intermediate and unlimited classifications shall also furnish a bonding ability statement or a line of credit letter issued by a bank, savings bank, or savings and loan association pursuant to G.S. 87-43.2(a)(4).
- (d) Special Classifications. A license applicant in the SP-EL, SP-PH, SP-WP, SP-ES or SP-SP classification must also include on the license application information verifying that the applicant is conducting a lawful business in the State of North Carolina in the license classification involved.

*History Note: Authority G.S. 87-42; 87-43.2; 87-43.3; 87-43.4; Eff. November 1, 1988. Amended Eff. February 1, 1995; April 1, 1993; February 1, 1990.*

### **.0402 LICENSE NAME REQUIREMENTS**

- (a) Issuance of License. The name in which a license is issued must be distinguishable upon the records of the Board from the name in which a license has already been issued. If the name requested, after deleting all spaces, punctuation marks, articles, prepositions, conjunctions and, whether abbreviated or not, "corporation," "incorporated," "company," or "limited," is not identical to the name in which a license has already been issued, it shall be distinguishable. The substitution of a numeral for a word that represents the same numeral shall not make the name distinguishable.
- (b) Name In Which Business Must Be Conducted. All electrical contracting business, including all business advertising and the submission of all documents and papers, conducted in the state of North Carolina by a licensee of the Board shall be conducted in the exact name in which the electrical contracting license is issued.
- (c) Notification of Address, Telephone, and Email Address. All licensees shall notify the Board in writing within 30 days of any change in location, mailing address, telephone number or email address.

*History Note: Authority G.S. 87-42; Eff. October 1, 1988. Amended Eff. July 1, 2011; March 1, 1999; February 1, 1996.*

### **.0403 SEPARATE LICENSE REQUIREMENTS**

- (a) A separate license certificate and license fee shall be required for each separate place of business with at least one listed qualified individual indicated thereon. No listed qualified individual shall be indicated on more than one license certificate at the same time except where a place of business has one listed qualified individual with licenses issued in different classifications.
- (b) As used in G.S. 87-43, the term "each separate place of business" means:
  - 1) the one place of business of a firm in the case where an electrical contracting firm conducts its business from only one place; and
  - 2) the principal place of business and each of the other places of business of a firm in the case where an electrical contracting firm is conducting its business from more than one place.

*History Note: Authority G.S. 87-42; 87-43; 87-43.2; Eff. October 1, 1988. Amended Eff. April 1, 1993; February 1, 1990.*

**.0404 ANNUAL LICENSE FEES**

(a) The fee for issuance of license, reissuance of license or license renewal in the various license classifications are as follows:

<b>LICENSE FEE SCHEDULE</b>	
<b>CLASSIFICATION</b>	<b>LICENSE FEE</b>
<b>Limited</b>	\$ 100.00
<b>Intermediate</b>	\$ 150.00
<b>Unlimited</b>	\$ 200.00
<b>Single Family Dwelling (SP-SFD)</b>	\$ 100.00
<b>Special Restricted (SP-FALV, SP-PH, SP-WP, SP-ES, SP-EL, SP-SP)</b>	\$ 100.00

(b) License fees may be in the form of check, money order, or credit card made payable to the Board. Payment must accompany any license or license renewal application filed with the Board.

*History Note: Authority G.S. 87-42; 87-44; Eff. October 1, 1988. Amended Eff. May 1, 1998; July 1, 1989. Temporary Amendment Eff. June 30, 2000; August 31, 2001. Amended Eff. July 1, 2023; July 1, 2020; October 1, 2017; July 1, 2015; January 1, 2008; December 4, 2002.*

**.0405 LICENSE RENEWAL DUE DATE**

(a) License renewal applications and fees are due 30 days prior to the license expiration date. An administrative fee of twenty-five dollars (\$25.00) shall be imposed upon applications received after the expiration date. Applications filed with the Board by mail shall be considered filed on the date such mail is postmarked.

(b) The Board will implement a system of staggered license renewals beginning July 1, 2002. Renewal applications for the year beginning July 1, 2002, will be mailed in the spring of 2002. Some licenses will be renewed for a 13-month period and the fee for such licenses will be the license fee set forth in rule .0404 of this section together with a one-twelfth (1/12) pro rata part of the license fee. Other renewals will be for varying monthly terms up to twenty-three (23) months and pro rata portions of the license fee for that classification will be added. Beginning July 1, 2003, all licenses will be renewed for twelve (12) month periods as the renewal date is reached.

*History Note: Authority G.S. 87-42; 87-44; Eff. October 1, 1988. Temporary Amended Eff. August 31, 2001. Amended Eff. July 18, 2002; February 1, 1990.*

**.0406 RENEWAL AFTER EXPIRATION OF ANNUAL LICENSE**

(a) Subject to Rule .0906 of this Subchapter, any licensee whose license has expired or been revoked solely because of failure to apply for renewal may apply and have the license renewed without further examination, and in compliance with the provisions contained in G.S. 87-44, if the applicant makes application within a period of 12 months immediately following the date the license expired.

(b) If the renewal application is filed more than 12 months immediately following the date the license expired, the applicant may have the license renewed if, during the 12 month period immediately preceding the date the application is filed with the Board, the applicant's listed qualified individual has obtained at least 500 hours of primary experience as defined in Rule .0202 of this Subchapter within the most recent 12 months, is current on the fee requirements set forth in Rule .0404 of this Section, pays the late fee set forth in Rule .0405 of this Section, and meets the continuing education requirements set forth in Rule .1101 of this Subchapter.

(c) An applicant failing to meet the requirements of Paragraphs (a) or (b) of this Rule may obtain a new license in accordance with Section .0200 of this Subchapter and Rule .0401 of this Section.

(d) The provisions of Section .0600 of this Subchapter apply to applicants whose last license expired on or before June 30, 1970.

*History Note: Authority G.S. 87-42; Eff. October 1, 1988. Amended Eff. July 1, 2016; March 1, 1999; February 1, 1990.*

**.0407 NUMBERING OF LICENSES**

(a) License numbers will not be related in any way to license classifications. However, each license number shall have a letter suffix added and shown on the license certificate to designate the classification of the license as follows:

- |                                     |   |
|-------------------------------------|---|
| Limited Classification              | (License No.) - L   |
| Intermediate Classification         | (License No.) - I   |
| Unlimited Classification            | (License No.) - U   |
| Single Family Detached              |   |
| Residential Dwelling Classification | (License No.) - SP-SFD  |
| Special Restricted Classification   | (License No.) - SP- With additional suffix letters denoting limitation of each classification established by the Board. |





- (b) Numbers for new licenses will be assigned in numerical order following the number of the last license previously issued.
- (c) A re-classified license will carry the same number as the old license which it replaces.
- (d) The person who is the initial qualified individual listed on a given license shall become the permanent possessor of the license number under which that license is issued, unless such person, his legal agent, personal representative, heirs or assigns furnished to the Board specific written authorization to assign his number to another, who then will become the possessor of that number. Each successive assignee, his legal agent, personal representative, heirs, or assigns shall have the right to make such assignments.

*History Note: Authority G.S. 87-42; 87-43.3; 87-43.4; Eff. October 1, 1988.*

## **SECTION .0500 - LICENSING OPTIONS**

### **.0501 RECLASSIFICATION OF CURRENT LICENSE**

- (a) A licensee may have the license classification lowered from unlimited to intermediate or limited, or from intermediate to limited, by:
  - 1) filing with the Board, in writing, a request for the lowering of the license classification; and
  - 2) surrendering the current license certificate to the Board for replacement as requested.
- (b) A licensee may have a license that was lowered pursuant to Paragraph (a) of this Rule raised to a classification up to and including that classification from which it was lowered by:
  - 1) filing with the Board, in writing, a request for the raising of the license classification;
  - 2) surrendering the current license certificate to the Board for replacement as requested; and
  - 3) paying the applicable license fee.
- (c) A limited or intermediate licensee whose license has not been lowered pursuant to Paragraph (a) of this Rule may have the license classification raised to intermediate or unlimited by:
  - 1) submitting an application on a form furnished by the Board indicating the classification of the license desired;
  - 2) meeting all the requirements for the classification in effect when the application is made, including taking and passing the examination; and
  - 3) paying the applicable license fee.
- (d) Licenses in the single family detached residential dwelling classification and in any special restricted classification are not subject to reclassification. A change in these classifications can be effected only on the basis of a new application subject to all of the normal processing and examination requirements.

*History Note: Authority G.S. 87-42; 87-43.3; 87-43.4; Eff. October 1, 1988. Amended Eff. October 1, 2017; March 1, 1999.*

### **.0502 LISTED QUALIFIED INDIVIDUAL CHANGING FROM ONE LICENSE TO ANOTHER**

A listed qualified individual indicated on a current active license may have his name removed from that license and added to another current active license by submitting to the Board:

- 1) his written request to remove his name from the license on which he is currently listed;
- 2) the license certificate on which he is currently listed;
- 3) a written request from the licensee on whose license the listed qualified individual is to be indicated, co-signed by the listed qualified individual being added; and
- 4) the current license certificate on which the listed qualified individual is to be indicated.

*History Note: Authority G.S. 87-42; 87-43; Eff. October 1, 1988. Amended Eff. February 1, 1990.*

### **.0503 LISTED QUALIFIED INDIVIDUAL OBTAINING OWN LICENSE**

Any listed qualified individual on any license may have his name removed from this license and obtain his own license upon meeting any current licensing requirements he has not previously met and submitting to the Board:

- 1) his written request to remove his name from the license on which he is currently listed;
- 2) the license certificate on which he is currently listed;
- 3) his license application on a form furnished by the Board; and
- 4) payment of the appropriate license fee.

*History Note: Authority G.S. 87-42; 87-43; Eff. October 1, 1988. Amended Eff. February 1, 1990.*

### **.0504 QUALIFIED INDIVIDUAL - LISTING OPTIONS AFTER EXPIRATION**

- (a) A qualified individual who was formerly but is not now listed on any license may apply for and obtain a license upon meeting all current licensing requirements not previously met and by submitting to the Board:
  - 1) a license application on a form furnished by the Board;
  - 2) payment of the appropriate license fee; and
  - 3) if more than 12 months has elapsed since the qualified individual was listed on an active license, information verifying that, during the 12 month period immediately preceding the date the application is filed with the Board, the qualified individual has obtained at least 500 hours primary experience as defined in Rule .0202 of this Subchapter within the most recent twelve months, is current on the fee requirements

set forth in 21 NCAC 18B .0404, pays the late fee set forth in 21 NCAC 18B .0404 and meets the continuing education requirements set forth in 21 NCAC 18B .1101.

- (b) A qualified individual who was formerly but is not now listed on any license may be listed on a current active license in the same or a lower classification as the classification of examination passed by submitting to the Board:
- 1) a written request from the licensee, co-signed by the qualified individual, requesting the Board to list the qualified individual on the license;
  - 2) the licensee's current license certificate; and
  - 3) if more than 12 months has elapsed since the qualified individual was listed on an active license, information verifying that, during the 12 month period immediately preceding the date the application is filed with the Board, the qualified individual has obtained at least 500 hours in an occupation of primary experience as defined in Rule .0202 of this Subchapter within the most recent twelve months, is current on the fee requirements set forth in 21 NCAC 18B .0404, pays the late fee set forth in 21 NCAC 18B .0404 and meets the continuing education requirements set forth in 21 NCAC 18B .1101.

*History Note: Authority G.S. 87-42; 87-43; Eff. October 1, 1988. Amended Eff. October 1, 2017; July 1, 2011; March 1, 1999; February 2, 1990.*

#### **.0505 QUALIFIED INDIVIDUAL - INITIAL LISTING OPTIONS**

A qualified individual who has passed the qualifying examination for a license but has never obtained a license nor been a listed qualified individual on any license shall:

- 1) be eligible to obtain a license in the same or lower classification as the classification of examination passed upon meeting all current licensing requirements not previously met and by submitting to the Board:
  - A) a license application on a form furnished by the Board;
  - B) payment of the appropriate license fee; and
  - C) if more than 12 months has elapsed since the qualified individual passed the qualifying examination for a license, information verifying that, during the 12 month period immediately preceding the date the application is filed with the Board, the qualified individual has obtained at least 500 hours primary experience as defined in Rule .0202 of this Chapter within the most recent twelve months, is current on the fee requirements set forth in 21 NCAC 18B .0404, pays the late fee set forth in 21 NCAC 18B .0404 and meets the continuing education requirements set forth in 21 NCAC 18B .1101.
- 2) be eligible to be included as a listed qualified individual on a current active license in the same or a lower classification as the classification of examination passed upon submitting to the Board:
  - A) a written request from the licensee, co-signed by the qualified individual, requesting the Board to list the qualified individual on the license;
  - B) the licensee's current license certificate; and
  - C) if more than 12 months has elapsed since the individual passed the qualifying examination for a license, information verifying that, during the 12 month period immediately preceding the date the application is filed with the Board, the qualified individual has obtained at least 500 hours primary experience as defined in Rule .0202 of this Chapter within the most recent twelve months, is current on the fee requirements set forth in 21 NCAC 18B .0404, pays the late fee set forth in 21 NCAC 18B .0404 and meets the continuing education requirements set forth in 21 NCAC 18B .1101.

*History Note: Authority G.S. 87-42; 87-43; Eff. Oct. 1, 1988. Amended Eff. October 1, 2017; July 1, 2011; March 1, 1999; Feb. 1, 1990.*

### **SECTION .0600 - RECLASSIFICATION OF FORMER CLASS I AND CLASS II LICENSES AND QUALIFIED INDIVIDUALS**

#### **.0601 LICENSES EXPIRING AND INDIVIDUALS QUALIFIED BEFORE JULY 1, 1970 (Repealed)**

*History Note: Authority G.S. 87-42; 87-49; Eff. October 1, 1988. Repealed Eff. July 1, 2011.*

#### **.0602 QUALIFIED INDIVIDUALS LISTED PRIOR TO JULY 1, 1970 (Repealed)**

*History Note: Authority G.S. 87-42; 87-49; Eff. October 1, 1988. Repealed Eff. July 1, 2011.*

### **SECTION .0700 - LICENSING RECIPROCITY**

#### **.0701 LICENSE BY RECIPROCITY**

- (a) The Board has entered into reciprocal licensing agreements with contractor licensing boards of several states whereby electrical contractors licensed by the other state boards may obtain a North Carolina electrical contracting license without written examinations provided:
- 1) the applicant furnishes to the Board a written statement from the state licensing board certifying that the applicant holds a current electrical contracting license issued by that board;
  - 2) the proposed qualified individual for the applicant is the same individual who is duly qualified for the license currently issued to the applicant by the state licensing board;
  - 3) the applicant files an application on a form provided by the Board requesting a license under the licensing reciprocity agreement currently in effect between the Board and the applicant's state licensing board;

- 4) except for the written examination requirement, the applicant furnishes to the Board information satisfactorily verifying to the Board that he meets all of the requirements in Sections .0200, .0300 and .0400 of this Subchapter applicable to the specific license classification requested;
  - 5) the applicant pays to the Board the annual license fee as required in Rule .0404 of this Subchapter for the specific license classification; and
  - 6) the license classification for which application is made is a classification for which the license from the other state is treated as equivalent under the agreement with that state.
- (b) The expiration date for each license issued under a reciprocal agreement shall be as prescribed in G.S. 87-44.
- (c) The renewal application due date and late filing penalty for a license issued under a reciprocal agreement shall be as prescribed in Rule .0405 of this Subchapter.
- (d) Copies of all reciprocity agreements and applications are available from the Board.
- (e) In the absence of a current reciprocity agreement in force between the contractor licensing board of a particular state and this Board, there is no waiver of examination.

#### STATE RECIPROCAL AGREEMENTS IN EFFECT AS OF 2023

Alabama  
Florida  
Georgia  
Louisiana  
Mississippi  
Ohio  
South Carolina  
Texas  
Tennessee  
Virginia  
West Virginia

*History Note: Authority G.S. 87-42; 87-50; Eff. October 1, 1988. Amended Eff. July 1, 2023; July 1, 2011; April 15, 2003; March 1, 1999; June 1, 1993.*

### **SECTION .0800 - SPECIAL RESTRICTED LICENSES**

#### **.0801 GENERAL PROVISIONS**

- (a) Types. A special restricted electrical contracting license classification is a classification established pursuant to G.S. 87-43.3 or by G.S. 87-43.4. Its purpose is to license persons, partnerships, firms, or corporations to engage or offer to engage in only a limited phase of electrical contracting work. Each special restricted license classification is separate from all other special restricted and regular license classifications. The General Assembly created the special restricted single-family dwelling electrical contracting license in G.S. 87-43.4. Pursuant to G.S. 87-43.3, the Board has established the following special restricted electrical contracting licenses:
- 1) fire alarm/low voltage wiring license (FA/LV);
  - 2) elevator license (SP-EL);
  - 3) plumbing, heating, and air conditioning license (SP-PH);
  - 4) groundwater pump license (SP-WP);
  - 5) electric sign license (SP-ES); and
  - 6) swimming pool license (SP-SP).
- (b) Limited Scope. A special restricted contracting license does not authorize the licensee to engage or offer to engage in the business of electrical contracting in general. It authorizes the licensee to engage or offer to engage only in the limited phase of electrical contracting described in the Rule in this Section that specifies the scope of the applicable special restricted license.
- (c) No Project Value Limit. The limitations concerning the dollar value of projects that may be undertaken by a limited or an intermediate licensee do not apply to special restricted licensees. Thus, the holder of a special restricted license may engage or offer to engage in any project authorized by the license regardless of the dollar value of the project.
- (d) Effect of Regular License. A licensee in the regular license classifications, whether limited, intermediate or unlimited, is qualified to engage or offer to engage in any activity authorized by a special restricted license, subject to the project value limitations contained in G.S. 87-43.3 and does not have to obtain a special restricted license.

*History Note: Authority G.S. 87-42; 87-43.3; 87-43.4; Eff. October 1, 1988. Amended Eff. January 1, 2010; Feb. 1, 1995; Feb. 1, 1990.*

#### **.0802 ESTABLISHING A SPECIAL RESTRICTED CLASSIFICATION**

- (a) The Board shall establish a special restricted license classification pursuant to G.S. 87-43.3 when it finds that:
- 1) the licensees who hold regular electrical contracting licenses are not meeting the need for the proposed electrical work to be authorized by the special restricted license; and
  - 2) establishing the special restricted license classification serves the public interest.



- (b) The Board shall establish special restricted license classifications by rulemaking conducted pursuant to the requirements of G.S. 150B, Article 2A.  
*History Note: Authority G.S. 87-42; 87-43.3; Eff. October 1, 1988. Amended Eff. May 1, 1998.*

**.0803 SCOPE OF SP-SFD LICENSE**

- (a) The following definitions apply in determination of the scope of work available to the holder of a SP-SFD license:
- 1) "Ancillary" with reference to the scope of a single-family residential dwelling is an appurtenance or an out-building or similar structure associated with the single-family dwelling such as a detached residential garage or carport, a farm or household equipment storage shed, a barn, a pump house, an electric fence, or yard lighting.
  - 2) "Habitation" means the occupancy of dwelling primarily or exclusively for residential purposes and includes the incidental use of the dwelling or its ancillaries for a business, commercial, or professional activity, such as providing hair dressing, medical, legal, consulting, or tax services, if:
    - A) the activity is incidental to the primary use of the dwelling as a residence;
    - B) no stock-in-trade is either displayed or sold on the premises; and
    - C) the full-time or part-time services of no more than one person who does not live at the dwelling are used in the activity.
  - 3) A "single family residential dwelling" is a building or a manufactured home that is designed and used only for habitation by one family and is not physically attached to any other building or structure. Cabanas, porches, room additions, and ancillary structures are considered part of a single-family dwelling if they are designed for and used only for residential purposes by the occupants of the dwelling.
- (b) A special restricted single family residential dwelling electrical contracting license (SP-SFD) authorizes the licensee to install, maintain, or repair only electrical wiring and devices that are in or on a single-family residential dwelling or are ancillary to a single-family residential dwelling. Electrical work within the scope of another special restricted license can be performed by a SP-SFD licensee without obtaining the other special restricted license as long as it is in or on a single-family residential dwelling or is ancillary to a single-family residential dwelling.

*History Note: Authority G.S. 87-42; 87-43.4; Eff. October 1, 1988. Amended Eff. July 1, 2011.*

**.0804 SCOPE OF SP-FA/LV LICENSE**

- (a) Definition. As used in this Chapter, fire alarm, burglar alarm and low voltage wiring systems are defined as:
- 1) wiring systems of 50 volts or less and control circuits directly associated therewith;
  - 2) wiring systems that have a voltage in excess of 50 volts and consist solely of power limited circuits meeting the definition of a Class II or Class III wiring system in the National Electrical Code or paging systems not in excess of 70 volts.
  - 3) line voltage wiring that has a voltage not in excess of 300 volts to ground and is installed from the load-side terminals of a disconnecting means or from a junction box, either of which has been installed by others, for the specific purpose of supplying the low voltage wiring system involved. Some low voltage wiring systems that meet this definition are exempt under Rule .0805;
  - 4) interconnected components wired to a common control panel either as a stand-alone fire alarm system or as part of a combination burglar/fire system to monitor and annunciate the status of evidence of flame, heat, smoke or water flow within a building or structure in accordance with the requirements of the N. C. State Building Code and NFPA 72; or
  - 5) alarm systems or devices used to detect burglary or theft as defined in G. S. 74D-2(a).
- (b) Scope. A special restricted fire alarm/low voltage electrical contracting license authorizes the licensee to install, maintain, or repair only low voltage wiring and directly related wiring. Wiring is directed related if it:
- 1) originates at the load-side terminals of a disconnecting means or junction box that:
    - A) has been installed, complete with line-side connections, by others for the purpose of supplying the low voltage wiring system involved; and
    - B) is permanently and legibly marked to identify the low voltage wiring system supplied; and
    - C) is not installed in a location considered as hazardous under the National Electrical Code.

*History Note: Authority G.S. 87-42; 87-43.3; Eff. October 1, 1988. Amended Eff. July 1, 2011; January 1, 2010.*

**.0805 EXEMPTION OF CERTAIN LOW VOLTAGE WIRING SYSTEMS**

Exemption. Except a fire alarm, burglar alarm, or low voltage wiring system as defined in Rule .0804, the installation, maintenance, or repair of low voltage wiring systems may be performed by those not licensed by the Board if all of the following conditions are met:

- 1) the system is not required by the N.C. State Building Code;
- 2) the low voltage control circuit and power supply is a Class II or Class III system as defined in the National Electrical Code other than that described in Rule .0804;
- 3) the system operates at a voltage not in excess of 50 volts or meets the provisions for sound-recording and similar equipment in the National Electrical Code;
- 4) no part of the system is installed in an area considered as hazardous under the National Electrical Code;
- 5) the system is current limited or protected by a circuit breaker, fuse, or other current limiting device; and
- 6) a failure in the system would not, in the opinion of the electrical inspector having jurisdiction, create a shock or fire hazard to persons or property.

*History Note: Authority G.S. 87-42; 87-43.3; Eff. October 1, 1988. Amended Eff. January 1, 2010.*



**.0806 SCOPE OF SP-EL LICENSE**

A special restricted elevator electrical contracting license (SP-EL) authorizes the licensee to install, maintain, or repair electrical wiring only as an incident to the licensee’s elevator, dumbwaiter, escalator, moving walk, or personnel hoist business. Furthermore, the license authorizes the licensee to install, maintain, or repair only electric wiring that:

- 1) is an integral part of an elevator, dumbwaiter, escalator, moving walk, or personnel hoist;
- 2) is electrically isolated from the building wiring by a safety switch or circuit breaker, that has been installed, complete with line-side connections, by others; and
- 3) originates at the load-side terminals of the protective isolating device, referred to as “beyond the disconnection means.”

*History Note: Authority G. S. 87-42; 87-43.3; Eff. October 1, 1988.*

**.0807 SCOPE OF SP-PH LICENSE**

A special restricting plumbing, heating, and air conditioning electrical contracting license (SP-PH) authorizes the licensee to install, maintain, or repair electric wiring or devices only as an incident to the licensee’s plumbing, heating, or air conditioning business. Furthermore, the license authorizes the licensee to install, maintain, or repair only wiring that is directly related to plumbing, heating, or air conditioning equipment and that:

- 1) is restricted to circuits or parts of circuits that operate at voltages not exceeding 600 volts, phase-to-phase;
- 2) is electrically isolated from the building wiring system by an overcurrent protective isolating device, such as a fused switch or circuit breaker, that:
  - A) has been installed, complete with line-side connections, by others;
  - B) is permanently and legibly marked to identify the equipment served by the device; and
  - C) is located within an enclosure intended solely for, and limited to, serving the specific plumbing, heating, or air conditioning equipment involved, or is located within a panelboard that serves the building wiring system and is likewise permanently and legibly marked to identify the equipment served by the device, provided wiring is installed by others from the load-side terminals of the device to a junction box, auxiliary gutter, or similar disconnecting means located outside the panelboard, but in sight of and within 50 feet of, the plumbing, heating, or air conditioning equipment served;
- 3) originates at the load-side terminals of the protective isolating device;
- 4) except for control wiring, is physically adjacent to the plumbing, heating, or air conditioning equipment from the equipment. Control wiring that receives its control power from the plumbing, heating, or air conditioning equipment involved may extend beyond these limits if the control voltage does not exceed 120 volts to ground and the wiring is protected from overcurrent; and
- 5) is not installed in a location considered as hazardous under the National Electrical Code.

*History Note: Authority G.S. 87-42; 87-43.3; Eff. October 1, 1988.*

**.0808 SCOPE OF SP-WP LICENSE**

A special restricted groundwater pump electrical contracting license (SP-WP) authorizes the licensee to install, maintain, or repair electric wiring only as an incident to the licensee’s groundwater pump business. Furthermore, the license authorizes the licensee to install, maintain, or repair only wiring that is directly related to a groundwater pump and that:

- 1) is restricted to circuits or parts of circuits that operate at voltages not exceeding 600 volts, phase-to-phase;
- 2) is electrically isolated from the building wiring system by an overcurrent protective isolating device that:
  - A) has been installed, complete with line-side connections, by others;
  - B) is permanently and legibly marked to identify the equipment served by the device; and
  - C) is located adjacent to the controller for the specific groundwater pump equipment involved and within an enclosure intended solely for, and limited to, serving that equipment;
- 3) originates at the load-side terminals of the protective isolating device; and
- 4) is not installed in a location considered as hazardous under the National Electrical Code.

*History Note: Authority G.S. 87-42; 87-43.3; Eff. October 1, 1988.*

**.0809 SCOPE OF SP-ES LICENSE**

(a) Definitions. As used in this Rule:

- 1) “Electric sign” means fixed, stationary, or portable self-contained, electrically illuminated utilization equipment that has words or symbols designed to convey information or attract attention. The term includes outline lighting.
- 2) “Outline lighting” means an arrangement of incandescent lamps or electric discharge tubing that outlines or otherwise calls attention to certain features, such as the shape of a building or the decoration of a window.

(b) Scope of License. A special restricted electric sign electrical contracting license (SP-ES) authorizes the licensee to install, maintain, or repair electric wiring or devices only as an incident to the licensee’s electric sign business. Furthermore, the license authorizes the licensee to install, maintain, or repair only wiring that is directly related to electric signs and is electrically isolated from the building wiring system. Wiring that is directly related differs depending on the type of sign involved:

- 1) Except for electric signs described in Paragraphs (2), (3), and (4) of this Rule, related wiring is the portion of the electric sign wiring that originates at the load-side terminals of a disconnecting means located immediately adjacent to the electric sign involved or originates within a junction box so located. Related wiring does not include the installation of the disconnecting means, complete with line-side connections, or the installation of the junction box, complete with free length circuit conductors to accommodate the connection of the related wiring in the box.



- 2) For electric sign installations having sign transformers installed physically apart from the sign, related wiring is the portion of the electric sign wiring that originates at the load-side terminals of a disconnecting means located immediately adjacent to the sign transformer supplying the electric sign involved or originates within a junction box so located. Related wiring does not include the installation of the disconnecting means, complete with line-side connections, or the installation of the junction box, complete with free-length circuit conductors to accommodate the connection of the related wiring in the box.
- 3) For free-standing electric sign installations supplied through underground circuit conductors, related wiring is the portion of the electric sign wiring that originates at a wiring termination point located at, within, or immediately above the permanent base for the sign structure. Related wiring does not include the installation of:
  - A) a junction box, located at, within or immediately above the permanent base for the sign, complete with free-length circuit conductors to accommodate the connection of the related wiring; or
  - B) if the base of the structure is suitable for use as a raceway, the installation of bushing, complete with free-length circuit conductors extending through to accommodate the connection of the related wiring within the sign structure raceway.
- 4) For electric signs specifically designed to be connected directly to the building wiring raceway or cable supply, related wiring is the portion of the electric sign wiring that originates at the point where the free-length circuit conductors extend through the building wiring raceway or cable at the specifically designed supply location for the electric sign involved. Related wiring does not include the installation of the building wiring raceway or cable system to the specifically designated point of supply for the electric sign involved, complete with free-length circuit conductors extending through the building wiring raceway or cable to accommodate the connection of the related wiring.
- 5) Except for the related wiring on the secondary side of sign transformers, related wiring is restricted to circuits or parts of circuits that operate at voltages not exceeding 600 volts, phase-to-phase.
- 6) No related wiring, or any part thereof, may be installed in a location considered as hazardous under the National Electrical Code.

*History Note: Authority G.S. 87-42; 87-43.3; Eff. October 1, 1988. Amended Eff. February 1, 1990.*

**.0810 SCOPE OF SP-SP LICENSE**

A special restricted swimming pool electrical contracting license (SP-SP) authorizes the licensee to install, maintain, or repair swimming pool bonding work only as an incident to the licensee’s business of installing, maintaining, or repairing swimming pools. Furthermore, the license authorizes the licensee to perform only the:

- 1) Bonding together of all of the following metal parts on or near a swimming pool installation:
  - A) all metal parts of the pool structure, including the reinforcing metal of the pool shell, coping stones, and deck;
  - B) all forming shells;
  - C) all metal fittings within or attached to the pool structure; and
  - D) all metal conduit, metal piping, fixed metal parts.
- 2) Installation of a common bonding grid, bonding together all parts listed in Subdivision (1);
- 3) Installation of the forming shells for lighting fixtures and underwater audio equipment;
- 4) Installation of the conduits extending from the lighting fixture and audio equipment forming shells to deck or junction boxes and the installation of the deck or junction boxes;
- 5) Installation of the lighting fixtures and audio equipment in their respective forming shells from the forming shells to the deck or junction boxes, leaving appropriate leads in the deck or junction boxes to which the circuit conductors can be connected by others;
- 6) Installation of a bonding conductor from the point of its connection to the common bonding grid to a readily accessible point at the circulating pump location.

*History Note: Authority G.S. 87-42; 87-43.3; Eff. October 1, 1988.*

**SECTION .0900 - VIOLATIONS AND CONTESTED CASE HEARINGS**

**.0901 APPLICANTS CONVICTED OF CRIMES**

The Board shall not consider the examination application of a person who has been convicted of a crime involving fraud or moral turpitude until at least one year has elapsed following the applicant’s completion of the terms and conditions of any punishment for the conviction, except for unsupervised probation.

*History Note: Authority G.S. 87-42; 87-43.3; 87-43.4; 87-47(a1)(4); Eff. October 1, 1988. Amended Eff. January 1, 2010; April 1, 1995; February 1, 1990.*

**.0902 CHARGES AND PRELIMINARY PROCEDURES**

- (a) The authority given to the Board’s executive director in this Rule shall include the executive director’s authority to delegate to other members of the Board’s staff.
- (b) Charges filed pursuant to G.S. 87-47(a4) shall be handled according to the progressive steps set out in Paragraphs (c) through (f) of this Rule.
- (c) A charge shall be handled initially by the executive director. The executive director may recommend to the Board that the charge be dismissed as unfounded or trivial, without a hearing. Unless so recommended, the executive director shall:
  - 1) issue and cause to be served on the accused a written notice of violation, including a proposed sanction pursuant to G.S. 87-47(a2) or civil penalty pursuant to G.S. 87-47(a3), or both, or
  - 2) give the accused written notice of the charge, including a request that the accused respond to it in writing within 20 days.



- (d) The executive director may, upon receipt and evaluation of the response, recommend to the Board that the charge be dismissed as unfounded or trivial, without a hearing, or the executive director may issue and cause to be served on the accused a written notice of violation, including a proposed sanction pursuant to G.S. 87-47(a2) or civil penalty pursuant to G.S. 87-47(a3), or both, or may turn the matter over to the Board's Disciplinary Review Committee.
- (e) The Disciplinary Review Committee will regularly review the actions of staff, and as to any particular matter, may take the actions outlined in paragraph (c) of this Rule or may schedule a conference before the Committee with the accused. If a conference is held, the Committee shall issue its findings in the form of a Recommended Order, that shall be provided to the accused and proposed for adoption by the full board as a Final Order in the absence of objection by the accused in 20 days.
- (f) The Board shall review the report and recommendations of the Disciplinary Review Committee and as to any matter may, without a hearing, dismiss the charge as unfounded or trivial, adopt the unopposed recommendations of the Committee, schedule a hearing on matters not resolved, or set an administrative hearing on the charge, notice of which may include a statement that the Board shall accept an offer in compromise pursuant to G.S. 87-47(e).
- (g) Before an administrative hearing is held, the Board may direct the disciplinary review committee to meet with the accused and the complainant in a final effort to effect a settlement.
- (h) Each notice of violation or Recommended Order shall include a statement of the right to request a hearing, pursuant to G.S. 87-47(a4).

*History Note: Authority G.S. 87-42; 87-47; Eff. October 1, 1988. Amended Eff. February 1, 1996; February 1, 1990. April 15, 2003.*

**.0903 PRELIMINARY DETERMINATION (Repealed)**

*History Note: Authority G.S. 87-42; 87-47; 150B, Article 3A; Eff. October 1, 1988. Repealed Eff. February 1, 1996.*

**.0904 ADMINISTRATIVE HEARING PROCEDURES**

The rules establishing procedures for contested cases adopted by the Office of Administrative Hearings as contained in Title 26, Chapter 3 of the North Carolina Administrative Code are hereby incorporated by reference, including subsequent amendments and editions, for contested cases for which the Board has authority to adopt rules under G.S. 150B-38(h). Provided, however, that if the case is conducted under G.S. 150B-40(b), the presiding officer shall have the powers and duties given to the Chief Administrative Law Judge or the presiding administrative law judge in Title 26, Chapter 3 of the North Carolina Administrative Code and that 26 NCAC 3 .0101(2), .0102(a)(2), .0103, .0126 and .0128 shall not apply. Copies of Title 26, Chapter 3 of the North Carolina Administrative Code are on file in the Board's office and may be obtained therefrom at the Board's actual cost of copying and mailing.

*History Note: Authority G.S. 87-42; 87-47; 150B-21.6; 150B-38(h); Eff. October 1, 1988. Amended Eff. May 1, 1998*

**.0905 JUDICIAL REVIEW (Repealed)**

*History Note: Authority G.S. 87-47; 150B-43; Eff. October 1, 1988. Repealed Eff. February 1, 1996.*

**.0906 LICENSE INELIGIBILITY AFTER VIOLATION**

- (a) Non-licensee. Any person, partnership, firm, or corporation not duly licensed by the Board and found to be engaging or offering to engage in a given electrical contracting project in North Carolina shall be subject to the provisions of G.S. 87-48. Furthermore, such person, partnership, firm, or corporation shall not be eligible for a qualifying examination or to obtain a license until the Board has found that any commitment to the project involving the person, partnership, firm or corporation has been voided and that the project, if continued, has been awarded to a person, partnership, firm or corporation duly licensed by the Board to engage or offer to engage in the project.
- (b) Licensee. Any licensee of the Board found to be engaging or offering to engage in a given electrical contracting project in North Carolina exceeding the project limitations or scope of the licensee's current license shall be subject to the provisions of G.S. 87-47 and 87-48. Furthermore, the licensee shall not be eligible to upgrade its license to a higher or general classification, or for a qualifying examination therefor, until the Board has found that any commitment to the project involving the licensee has been voided and that the project, if continued, has been awarded to a person, partnership, firm or corporation duly licensed by the Board to engage or offer to engage in the project.

*History Note: Authority G.S. 87-42; 87-43; 87-47; 87-48; Eff. October 1, 1988. Amended Eff. February 1, 1990.*

**.0907 RESPONSIBILITY OF LICENSEES AND QUALIFIED INDIVIDUALS**

- (a) "Gross negligence" within the meaning of G.S. 87-47 means such lack of due care as evidences reckless disregard of human life or the safety of the person exposed to its dangerous effects or creating a clear and present danger of personal injury, illness, or property damage, or that entire want of care as would raise the presumption of a conscious indifference to the rights of others, which is equivalent to an intentional violation of the law.
- (b) "Gross incompetence" refers to such lack of knowledge, supervision, or technical competence as to correspond or create risk similar to the consequences of gross negligence.
- (c) "Supervision" within the meaning of G.S. 87-43 refers to that degree of attendance, participation and oversight which is necessary and sufficient to ensure that the project is carried out in a workmanlike manner, with the requisite skill and that the installation is made properly, safely and in accordance with applicable codes and rules. Supervision means active onsite review of the work by a qualified individual while the work is in progress.

*History Note: Authority G.S. 87-42; 87-50; Eff. April 15, 2003.*



**.0908 MALPRACTICE**

- (a) The provisions of the North Carolina Building Code, including the provisions of the National Electrical Code as modified and adopted by the Building Code Council of North Carolina from time to time, is a minimum standard of competence applicable to contractors licensed by the Board. Malpractice consists in failure to design and install systems that meet or exceed the minimum standards of the North Carolina State Building Code, Manufacturer's specifications and installation instructions and standards prevailing in the industry.
- (b) Malpractice may consist in lack of knowledge of Code, Manufacturer's specifications, and industry standards, in a failure to apply such technical knowledge, in undertaking a project that is not planned and supervised, or in undertaking a project that the licensee may not reasonably expect to complete timely and in accordance with codes, specifications, and industry standards.
- (c) Where work is carried out by employees of the licensee, failure to provide supervision of such employees, whether by consistent absence from the workplace or jobsite, or as demonstrated by the failure of the work to comply with this rule, also constitutes malpractice on the part of the licensee.
- (d) Where more than one qualified individual, as defined in G.S.87-41.1(1) is employed at a firm, each such person is responsible for the work of the firm.

*History Note: Authority G.S. 87-42; 87-47; 87-50; Eff. April 15, 2003.*

**.0909 MALPRACTICE FURTHER DEFINED**

- (a) A licensee of the Board shall ensure that a permit is obtained from the local Code Enforcement official before commencing any work for which a license is required by the Board and ensure that a request for final inspection is made by him, the general contractor, or the owner within 10 days of completion of the work for which a license is required, absent agreement with both the owner and the local Code Enforcement official. Absent agreement with the local Code Enforcement official, the licensee is not relieved by the Board of responsibility to arrange inspection until a certificate of compliance or the equivalent is obtained from the local Code Enforcement official or the licensee has clear and convincing evidence of his effort to obtain same.
- (b) A licensed contractor shall not allow a permit to be obtained or his license number to appear upon a permit except for which he or his employees perform, over which he will provide general supervision until the completion of the work, for which he holds an executed contract with the licensed general contractor or property owner and for which he receives all contractual payments.
- (c) The failure of a licensee or qualified individual to comply with the permit and inspection obligations outlined in this rule is considered by the Board as evidence of malpractice, gross incompetence, or gross misconduct, in the use of license or qualification from the Board.

*History Note: Authority G.S. 87-42; 87-47; 153A-357; 160A-417; Eff. July 1, 2011.*

**SECTION .1000 – DESCRIPTION OF FORMS, CERTIFICATES AND PUBLICATIONS (Repealed)**

*History Note: Repealed Eff. March 1, 1999.*

**SECTION .1100 - CONTINUING EDUCATION**

**.1101 CONTINUING EDUCATION REQUIREMENTS: LISTED QUALIFIED INDIVIDUALS**

- (a) Every listed qualified individual, including listed qualified individuals pursuant to G.S. 87-50, shall complete continuing education for each license period (July 1 - June 30) to renew the license on which the qualified individual is currently listed, for the next license period, except as follows:
  - 1) individuals becoming qualified by examination during the 12-month period immediately preceding the license renewal date;
  - 2) qualified individuals unable to fulfill the required number of hours as the result of illness as certified in writing by the attending physician; or
  - 3) persons presenting approved courses of continuing education.
- (b) The number of required contact hours for every listed qualified individual shall be determined by the classification of license on which the qualified individual is currently listed as follows:
  - 1) qualified individuals currently listed on a license in the limited, intermediate, unlimited, and special restricted single family dwelling classifications shall complete at least eight hours of approved continuing education for license renewal; and
  - 2) qualified individuals currently listed on a license in the special restricted fire alarm/low voltage (FALV), special restricted elevator (SP-EL), special restricted plumbing and heating (SP-PH), special restricted ground water pump (SP-WP), special restricted electric sign (SP-ES) and special restricted swimming pool (SP-SP) classifications shall complete at least four hours of approved continuing education for license renewal.
- (c) The Board, pursuant to Rules .1102 and .1103 of the Section, approves courses. Because of differences in the electrical contracting industry and individual needs of listed qualified individuals, each qualified individual must exercise judgment in selecting courses for which continuing education is claimed and in choosing only those courses that will advance the individual's knowledge.
- (d) Course sponsors may be colleges or universities, community colleges, trade associations, providers of self-study programs, employers, third party professional examination companies, private instructors and the like.
- (e) North Carolina listed qualified individuals residing within the state must obtain the required continuing education hours by taking a course provided by an approved sponsor.





- (f) North Carolina listed qualified individuals residing outside of North Carolina, including listed qualified individuals pursuant to G.S. 87-50, may obtain credit for courses offered in North Carolina. They may also obtain credit for courses offered in their state, province or country of residence provided the Board subsequently approves the courses taken, pursuant to Rule .1102(b) of this Section.
- (g) Effective for renewals on or after July 1, 2008, all persons seeking to renew qualification must demonstrate that a minimum of one-half the continuing education hours for each annual license period were obtained by in-person classroom or seminar attendance.

*History Note: Authority G.S. 87-42; 87-44.1; Eff. October 1, 1990. Amended Eff. January 1, 2010; January 1, 2006; March 1, 1990.*

#### **.1102 MINIMUM REQUIREMENTS FOR COURSE SPONSOR APPROVAL**

- (a) Each course sponsor shall submit an application for continuing education course sponsor approval to the Board on a form provided by the Board by March 1 of the year prior to the license period (July 1 - June 30) in which the course will be offered. The application shall include:
  - 1) the name of the sponsor;
  - 2) sponsor contact person, address, telephone number and email address;
  - 3) course title and outline;
  - 4) course contact hours;
  - 5) schedule of courses, if established, including dates, time, and locations;
  - 6) course fee; and
  - 7) names and credentials of each instructor.
- (b) To qualify as an approved continuing education course sponsor:
  - 1) all courses offered by the sponsor shall last no fewer than the minimum number of contact hours required for the license classification pursuant to Rule .1101(b) of this Section; and
  - 2) all courses offered by the sponsor shall cover articles of the current National Electrical Code, NFPA 72 and reference materials for Fire Alarm Systems; G.S. 87, Article 4; 21 NCAC 18B; or other subject matter satisfying the requirements in G.S. 87-44.1 as approved by the Board.
- (c) The course sponsor or instructor shall provide the Board with a certified class roster of all attending qualified individuals within 10-days after the completion of each course.
- (d) The course sponsor or instructor shall provide each attending qualified individual with a certificate of completion within 10 days after completion of each course.
- (e) The Board shall approve or deny applications at its regular scheduled meetings.
- (f) Upon approval of the application, each approved sponsor shall agree to conduct courses in accordance with this Section and the applicant shall indicate its agreement by signing a continuing education sponsor agreement form provided by the Board.

*History Note: Authority G.S. 87-42; 87-44.1; Eff. October 1, 1990. Amended Eff. July 1, 2011; January 1, 2006; March 1, 1999.*

#### **.1103 MINIMUM REQUIREMENTS FOR COURSE INSTRUCTOR APPROVAL**

- (a) Each course instructor shall submit an application for continuing education course instructor approval to the Board on a form provided by the Board by March 1 of the year prior to the fiscal year (July 1 - June 30) in which the course will be offered. The application shall include but is not limited to:
  - (a) The name of the instructor;
  - (b) Instructor's address, telephone number and email address;
  - (c) The name of the course sponsor;
  - (d) Course title;
  - (e) Course contact hours; and
  - (f) Qualifications of instructor.
- (b) The Board shall approve courses when:
  - 1) The proposed course outline demonstrates content related to the technical, practical and business aspects of electrical contracting so as to have educational value consistent with the number of hours credit sought and the class is to be offered at a location conducive to learning; and
  - 2) The course is to be taught by qualified individuals as defined in G.S. 87-41.1, by persons who have demonstrated subject matter knowledge on a test administered by the Board, by persons holding qualifications as a code enforcement official issued by the Code Official Qualification Board or by persons who otherwise establish knowledge of the material in the course outline.
- (c) The Board may deny an application for course approval if it finds that the sponsor or proposed instructor has previously failed to comply with the terms of any agreement as provided in Paragraph (g) of this Rule or the rules of the Board.
- (d) The application for course approval shall be submitted together with the application for continuing education course sponsor approval as prescribed in Rule .1102 of this Section.
- (e) The Board shall approve or deny applications at a regular meeting.
- (f) Appeals from denials shall be heard by the Board at the next scheduled meeting of the Board.
- (g) Upon approval of a course, sponsor and the instructor teaching the approved course shall agree to conduct courses in accordance with this Section and the information represented on the application and shall indicate his agreement by signing a continuing education agreement form provided by the Board.

*History Note: Statutory Authority G.S. 87-42; 87-44.1; Eff. October 1, 1990. Amended Eff. July 1, 2011; January 1, 2006; April 1, 1993.*



**.1104 CONTACT HOURS**

- (a) Approved courses must be offered for no fewer than two contact hours.
- (b) Credit shall be granted to the qualified individual only upon completion of an entire course.
- (c) When a qualified individual has completed more than the required number of hours of continuing education in any one license period, the extra hours shall be carried forward in multiples as specified in Paragraph (a) of this Rule and treated as hours earned in the following one or two additional license periods.
- (d) No credit shall be granted for courses attended prior to being qualified by examination.

*History Note: Authority G.S. 87-42; 87-44.1; Eff. October 1, 1990. Amended Eff. February 1, 2006; March 1, 1999.*

**.1105 COMPUTATION OF CONTINUING EDUCATION HOURS**

- (a) Group Courses: Non-college. Continuing education credit for a group course that is not part of a college curriculum is given based on contact hours. A contact hour is 50 minutes of instruction. Credit is granted only for full contact hours.
- (b) College Courses. Continuing education credit for a college course in the college curriculum is given based on college credit hours. One semester hour of college credit is 16 contact hours; and one continuing education unit is 10 contact hours.
- (c) Self-Study Courses. Continuing education credit for a self-study course is given based on the average number of contact hours needed to complete the course. The course shall include a study text and a written examination having a minimum of 25 questions for each two contact hours course credit and a minimum passing grade of 70. A sponsor must determine the average number of contact hours it takes to complete the self-study course and submit this information with its application for continuing education course sponsor approval.
- (d) Examination. Continuing education credit for an examination is given based on the type of examination, number of questions, number of hours permitted to take the examination, and passing grade. The examination shall include a minimum of 25 questions for each two contact hours course credit and a minimum passing grade of 70. A sponsor must set the number of hours permitted to take the examination and submit this information with its application for continuing education course sponsor approval.
- (e) Totalling Annual Hours. No credit shall be allowed for a course having fewer than two contact hours required for the license classification pursuant to Rule .1101(b) of this Section. Credit hours for more than one year are subject to the provisions of Rule .1104(c) of this Section.

*History Note: Authority G.S. 87-42; 87-44.1; Eff. October 1, 1990. Amended Eff. January 1, 2006; March 1, 1999.*

**.1106 LIST OF APPROVED COURSE SPONSORS AND INSTRUCTORS**

In July of each year the Board shall post a link to the Board website that shall include:

- 1. All approved course sponsors and instructors for that fiscal year; and
- 2. Contact information for all approved course sponsors and instructors.

*History Note: Statutory Authority G.S. 87-42; 87-44.1; Eff. October 1, 1990. Amended Eff. January 1, 2006.*

**.1107 ADVERTISEMENTS BY APPROVED COURSE SPONSORS AND INSTRUCTORS**

Approved course sponsors and instructors who state in their advertisements, brochures, or other course descriptions that a particular course meets the requirement of the North Carolina State Board of Examiners of Electrical Contractors for continuing education shall so state exactly as follows:

This course, when offered during fiscal year \_\_\_\_\_, meets the requirements of the North Carolina State Board of Examiners of Electrical Contractors for \_\_\_\_\_ contact hours of continuing education credit. This course is not sponsored by the Board.

*History Note: Statutory Authority G.S. 87-42; 87-44.1; Eff. October 1, 1990.*

**.1108 REVOCATION OF COURSE SPONSOR OR INSTRUCTOR APPROVAL**

- (a) The Board may revoke, suspend, or terminate the agreement with any approved continuing education course sponsor and/or instructor if the Board determines that either has failed to comply with the terms of the agreement or the Rules of the Board.
- (b) The Board shall have the authority to monitor courses to determine whether the course sponsor and instructor are complying with the terms of the agreement and the rules of the Board.

*History Note: Statutory Authority G.S. 87-42; 87-44.1; Eff. October 1, 1990.*

## OTHER ELECTRICAL CONTRACTOR RELATED LAWS

### NC GENERAL STATUTES: CHAPTER 66 - ARTICLE 4

#### Electrical Materials, Devices, Appliances and Equipment.

**66-23. Sale of electrical goods regulated.**

**66-24. Identification marks required.**

**66-25. Acceptable listings as to safety of goods.**

**66-26. Legal responsibility of proper installations unaffected.**

**66-27. Violation made misdemeanor.**

**66-27.01. Enforcement.**

**§ 66-23. Sale of electrical goods regulated.**

Every person, firm, or corporation before selling, offering for sale, assigning, or disposing of by gift as premiums or in any similar manner any electrical material, devices, appliances or equipment shall first determine if such electrical materials, devices, appliances and equipment comply with the provision of this Article. (1933, c. 555, s. 1; 1989, c. 681, s. 1.)

**§ 66-24. Identification marks required.**

All electrical materials, devices, appliances and equipment shall have the maker's name, trademark, or other identification symbol placed thereon, together with such other markings giving voltage, current, wattage, or other appropriate ratings as may be necessary to determine the character of the material, device, appliance or equipment and the use for which it is intended; and it shall be unlawful for any person, firm or corporation to remove, alter, change or deface the maker's name, trademark or other identification symbol. (1933, c. 555, s. 2; 1989, c. 681, s. 1.)

**§ 66-25. Acceptable listings as to safety of goods.**

(a) All electrical materials, devices, appliances, and equipment shall be evaluated for safety and suitability for intended use. Except as provided in subsection (b) of this section, this evaluation shall be conducted in accordance with nationally recognized standards and shall be conducted by a qualified testing laboratory. The Commissioner of Insurance, through the Engineering Division of the Department of Insurance, shall implement the procedures necessary to approve suitable national standards and to approve suitable qualified testing laboratories. The Commissioner may assign his authority to implement the procedures for specific materials, devices, appliances, or equipment to other agencies or bodies when they would be uniquely qualified to implement those procedures. In the event that the Commissioner determines that electrical materials, devices, appliances, or equipment in question cannot be adequately evaluated through the use of approved national standards or by approved qualified testing laboratories, the Engineering Division of the Department of Insurance shall specify any alternative evaluations which safety requires. The Engineering Division of the Department of Insurance shall keep in file, where practical, copies of all approved national standards and resumes of approved qualified testing laboratories.

(b) Electrical devices, appliances, or equipment used by the Division of Adult Correction of the Department of Public Safety in institutional kitchens and manufacturing equipment used by Correction Enterprises are exempt from the evaluation requirement of subsection (a) of this section. (1933, c. 555, s. 3; 1989, c. 681, s. 1; 2013-289, s. 11; 2014-100, s. 16C.4; 2015-241, s. 16C.13A.)

**§ 66-26. Legal responsibility of proper installations unaffected.**

This Article shall not be construed to relieve from or to lessen the responsibility or liability of any party owning, operating, controlling or installing any electrical materials, devices, appliances or equipment for damages to persons or property caused by any defect therein, nor shall the electrical inspector, the Commissioner, or agents of the Commissioner be held as assuming any such liability by reason of the approval of any material, device, appliance or equipment authorized herein. (1933, c. 555, s. 4; 1989, c. 681, s. 1.)

**§ 66-27. Violation made misdemeanor.**

Any person, firm or corporation who shall violate any of the provisions of this Article shall be guilty of a Class 2 misdemeanor. (1933, c. 555, s. 5; 1989, c. 681, s. 1; 1993, c. 539, s. 509; 1994, Ex. Sess., c. 24, s. 14(c).)

**§ 66-27.01. Enforcement.**

The Commissioner or his designee or the electrical inspector of any State or local governing agency may initiate any appropriate action or proceedings to prevent, restrain, or correct any violation of this Article. The Commissioner or his designee, upon showing proper credentials and in discharge of his duties pursuant to this Article may, at reasonable times and without advance notice, enter and inspect any facility within the State in which there is reasonable cause to suspect that electrical materials, devices, appliances, or equipment not in conformance with the requirements of this Article are being sold, offered for sale, assigned, or disposed of by gift, as premiums, or in any other similar manner. (1989, c. 681, s. 1; 1997-456, s. 27.)

**NC GENERAL STATUTES: CHAPTER 160D – ARTICLE 11****Local Planning and Development Regulation – Building Code Enforcement**

- 160D-1101. Definitions.
- 160D-1102. Building code administration.
- 160D-1103. Qualifications of inspectors.
- 160D-1104. Duties and responsibilities.
- 160D-1104.1. Remote inspection alternative.
- 160D-1105. Other arrangements for inspections.
- 160D-1106. Alternate inspection method for component or element.
- 160D-1107. Mutual aid contracts.
- 160D-1108. Conflicts of interest.
- 160D-1109. Failure to perform duties.
- 160D-1110. Building permits.
- 160D-1111. Expiration of building permits.
- 160D-1112. Changes in work.
- 160D-1113. Inspections of work in progress.
- 160D-1114. Appeals of stop orders.
- 160D-1115. Revocation of building permits.
- 160D-1116. Certificates of compliance; temporary certificates of occupancy.
- 160D-1117. Periodic inspections.
- 160D-1118. Defects in buildings to be corrected.
- 160D-1119. Unsafe buildings condemned.
- 160D-1120. Removing notice from condemned building.
- 160D-1121. Action in event of failure to take corrective action.
- 160D-1122. Order to take corrective action.
- 160D-1123. Appeal; finality of order if not appealed.
- 160D-1124. Failure to comply with order.
- 160D-1125. Enforcement.
- 160D-1126. Records and reports.
- 160D-1127. Appeals.
- 160D-1128. Fire limits.

**§ 160D-1101. Definitions.**

As used in this Article, the following terms shall have their ordinary meaning and shall also be read to include the following:

- (1) Building or buildings. - Includes other structures.
- (2) Governing board or board of commissioners. - Includes the Tribal Council of a federally recognized Indian tribe.
- (3) Local government. - Includes a federally recognized Indian tribe, and, as to such tribe, includes lands held in trust for the tribe.
- (4) Public officer. - Includes the officer or officers who are authorized by regulations adopted hereunder to exercise the powers prescribed by the regulations and by this Article. (2019-111, s. 2.4; 2020-3, s. 4.33(a); 2020-25, s. 51(a), (b), (d).)

**§ 160D-1102. Building code administration.**

A local government may create an inspection department and may appoint inspectors who may be given appropriate titles, such as building inspector, electrical inspector, plumbing inspector, housing inspector, zoning inspector, heating and air-conditioning inspector, fire prevention inspector, or deputy or assistant inspector, or another title generally descriptive of the duties assigned. Every local government shall perform the duties and responsibilities set forth in G.S. 160D-1104 either by (i) creating its own inspection department, (ii) creating a joint inspection department in cooperation with one or more other units of local government, pursuant to Part 1 of Article 20 of Chapter 160A of the General Statutes, (iii) contracting with another unit of local government for the provision of inspection services pursuant to Part 1 of Article 20 of Chapter 160A of the General Statutes, or (iv) arranging for the county in which a city is located to perform inspection services within the city's jurisdiction as authorized by G.S. 160D-1104 and G.S. 160D-202.

In the event that any local government fails to provide inspection services or ceases to provide inspection services, the Commissioner of Insurance shall arrange for the provision of inspection services, either through personnel employed by the department or through an arrangement with other units of government. In either event, the Commissioner has and may exercise within the local government's planning and development regulation jurisdiction all powers made available to the governing board with respect to building inspection under this Article and Part 1 of Article 20 of Chapter 160A of the General Statutes. Whenever the Commissioner has intervened in this manner, the local government may assume provision of inspection services only after giving the Commissioner two years' written notice of its intention to do so; however, the Commissioner may waive this requirement or permit assumption at an earlier date upon finding that an earlier assumption will not unduly interfere with arrangements made for the provision of those services. (2019-111, s. 2.4; 2020-3, s. 4.33(a); 2020-25, s. 51(a), (b), (d); 2021-88, s. 1(f).)



**§ 160D-1103. Qualifications of inspectors.**

No local government shall employ an inspector to enforce the State Building Code who does not have one of the following types of certificates issued by the North Carolina Code Officials Qualification Board attesting to the inspector's qualifications to hold such position: (i) a probationary certificate, (ii) a standard certificate, or (iii) a limited certificate which shall be valid only as an authorization to continue in the position held on the date specified in G.S. 143-151.13(c) and which shall become invalid if the inspector does not successfully complete in-service training specified by the Qualification Board within the period specified in G.S. 143-151.13(c). An inspector holding one of the above certificates can be promoted to a position requiring a higher-level certificate only upon issuance by the Board of a standard certificate or probationary certificate appropriate for such new position. (2019-111, s. 2.4; 2020-3, s. 4.33(a); 2020-25, s. 51(a), (b), (d).)

**§ 160D-1104. Duties and responsibilities.**

- (a) The duties and responsibilities of an inspection department and of the inspectors in it are to enforce within their planning and development regulation jurisdiction State and local laws relating to the following:
  - (1) The construction of buildings and other structures.
  - (2) The installation of such facilities as plumbing systems, electrical systems, heating systems, refrigeration systems, and air-conditioning systems.
  - (3) The maintenance of buildings and other structures in a safe, sanitary, and healthful condition.
  - (4) Other matters that may be specified by the governing board.
- (b) The duties and responsibilities set forth in subsection (a) of this section include the receipt of applications for permits and the issuance or denial of permits, the making of any necessary inspections in a timely manner, the issuance or denial of certificates of compliance, the issuance of orders to correct violations, the bringing of judicial actions against actual or threatened violations, the keeping of adequate records, and any other actions that may be required in order adequately to enforce those laws. The governing board has the authority to enact reasonable and appropriate provisions governing the enforcement of those laws.
- (c) In performing the specific inspections required by the North Carolina Building Code, the inspector shall conduct all inspections requested by the permit holder for each scheduled inspection. For each requested inspection, the inspector shall inform the permit holder of instances in which the work inspected fails to meet the requirements of the North Carolina Residential Code for One- and Two-Family Dwellings or the North Carolina Building Code.
- (d) Except as provided in G.S. 160D-1117 and G.S. 160D-1207, a local government may not adopt or enforce a local ordinance or resolution or any other policy that requires regular, routine inspections of buildings or structures constructed in compliance with the North Carolina Residential Code for One- and Two-Family Dwellings in addition to the specific inspections required by the North Carolina Building Code without first obtaining approval from the North Carolina Building Code Council. The North Carolina Building Code Council shall review all applications for additional inspections requested by a local government and shall, in a reasonable manner, approve or disapprove the additional inspections. This subsection does not limit the authority of the local government to require inspections upon unforeseen or unique circumstances that require immediate action. In performing the specific inspections required by the North Carolina Residential Building Code, the inspector shall conduct all inspections requested by the permit holder for each scheduled inspection. For each requested inspection, the inspector shall inform the permit holder of instances in which the work inspected is incomplete or otherwise fails to meet the requirements of the North Carolina Residential Code for One- and Two-Family Dwellings or the North Carolina Building Code. When a subsequent inspection is conducted to verify completion or correction of instances of Code noncompliance, any additional violations of the Code noted by the inspector on items already approved by the inspections department may delay the issuance of a temporary certificate of occupancy, but the inspections department shall not charge a fee for reinspection of those items.
- (e) Each inspection department shall implement a process for an informal internal review of inspection decisions made by the department's inspectors. This process shall include, at a minimum, the following:
  - (1) Initial review by the supervisor of the inspector.
  - (2) The provision in or with each permit issued by the department of (i) the name, phone number, and e-mail address of the supervisor of each inspector and (ii) a notice of availability of the informal internal review process.
  - (3) Procedures the department must follow when a permit holder or applicant requests an internal review of an inspector's decision.
  - (4) Nothing in this subsection limits or abrogates any rights available under Chapter 150B of the General Statutes to a permit holder or applicant.
- (f) (Expires October 1, 2021 - see note) If a specific building framing inspection as required by the North Carolina Residential Code for One- and Two-Family Dwellings results in 15 or more separate violations of that Code, the inspector shall forward a copy of the inspection report to the Department of Insurance. (2019-111, s. 2.4; 2020-3, s. 4.33(a); 2020-25, ss. 28(a), (b), 51(a), (b), (d); 2021-117, s. 12.5(b); 2021-121, s. 4(a).)

**§ 160D-1104.1. Remote inspection alternative.**

An inspection department shall implement remote inspection procedures in accordance with criteria and procedures developed pursuant to G.S. 143-139(b)(3). An inspection department must provide the option to elect remote inspections for a project to a building permit applicant. An inspection department must specify the extent to which a project is eligible for remote inspections at the time of building permit issuance. (2021-117, s. 12.5(c).)

**§ 160D-1105. Other arrangements for inspections.**

A local government may contract with an individual who is not a local government employee but who holds one of the applicable certificates as provided in G.S. 160D-1103 or with the employer of an individual who holds one of the applicable certificates as provided in G.S. 160D-1103. (2019-111, s. 2.4; 2020-3, s. 4.33(a); 2020-25, s. 51(a), (b), (d).)



**§ 160D-1106. Alternate inspection method for component or element.**

- (a) Notwithstanding the requirements of this Article, a local government shall accept and approve, without further responsibility to inspect, a design or other proposal for a component or element in the construction of buildings from an architect licensed under Chapter 83A of the General Statutes or professional engineer licensed under Chapter 89C of the General Statutes provided all of the following apply:
- (1) When required by the North Carolina State Building Code, the submission design or other proposal is completed under valid seal of the licensed architect or licensed professional engineer.
  - (2) Field inspection of the installation or completion of a component or element of the building is performed by a licensed architect or licensed professional engineer or a person under the direct supervisory control of the licensed architect or licensed professional engineer.
  - (3) The licensed architect or licensed professional engineer under subdivision (2) of this subsection provides the local government with a signed written document certifying that the component or element of the building inspected under subdivision (2) of this subsection is in compliance with the North Carolina State Building Code or the North Carolina Residential Code for One- and Two-Family Dwellings. The certification required under this subdivision shall be provided by electronic or physical delivery, [and] its receipt shall be promptly acknowledged by the local government through reciprocal means. The certification shall be made on a form created by the North Carolina Building Code Council which shall include at least the following:
    - a. Permit number.
    - b. Date of inspection.
    - c. Type of inspection.
    - d. Contractor's name and license number.
    - e. Street address of the job location.
    - f. Name, address, and telephone number of the person responsible for the inspection.
- (a2) In accepting certifications of inspections under subsection (a) of this section, a local government shall not require information other than that specified in this section.
- (b) Upon the acceptance and approval receipt of a signed written document by the local government as required under subsection (a) of this section, notwithstanding the issuance of a certificate of occupancy, the local government, its inspection department, and the inspectors are discharged and released from any liabilities, duties, and responsibilities imposed by this Article with respect to or in common law from any claim arising out of or attributed to the component or element in the construction of the building for which the signed written document was submitted.
- (c) With the exception of the requirements contained in subsection (a) of this section, no further certification by a licensed architect or licensed professional engineer is required for any component or element designed and sealed by a licensed architect or licensed professional engineer for the manufacturer of the component or element under the North Carolina State Building Code or the North Carolina Residential Code for One- and Two-Family Dwellings.
- (d) As used in this section, the following definitions apply:
- (1) Component. - Any assembly, subassembly, or combination of elements designed to be combined with other components to form part of a building or structure. Examples of a component include an excavated footing trench containing no concrete, a foundation, and a prepared underslab with slab-related materials without concrete. The term does not include a system.
  - (2) Element. - A combination of products designed to be combined with other elements to form all or part of a building component. The term does not include a system. (2019-111, s. 2.4; 2020-3, s. 4.33(a); 2020-25, ss. 29, 51(a), (b), (d); 2020-74, s. 31.)

**§ 160D-1107. Mutual aid contracts.**

- (a) Any two or more cities or counties may enter into contracts with each other to provide mutual aid and assistance in the administration and enforcement of State and local laws pertaining to the North Carolina State Building Code. Mutual aid contracts may include provisions addressing the scope of aid provided, for reimbursement or indemnification of the aiding party for loss or damage incurred by giving aid, for delegating authority to a designated official or employee to request aid or to send aid upon request, and any other provisions not inconsistent with law.
- (b) Unless the mutual aid contract says otherwise, while working with the requesting city or county under the authority of this section, a Code-enforcement official shall have the same jurisdiction, powers, rights, privileges, and immunities, including those relating to the defense of civil actions and payment of judgments, as the Code-enforcement officials of the requesting agency.
- (c) Nothing in this section shall be construed to deprive any party to a mutual aid contract under this section of its discretion to send or decline to provide aid to another party to the contract under any circumstances, whether or not obligated by the contract to do so. In no case shall a party to a mutual aid contract or any of its officials or employees be held to answer in any civil or criminal action for declining to send aid whether or not obligated by contract to do so. (2019-111, s. 2.4; 2020-3, s. 4.33(a); 2020-25, s. 51(a), (b), (d).)

**§ 160D-1108. Conflicts of interest.**

Staff members, agents, or contractors responsible for building inspections shall comply with G.S. 160D-109(c). No member of an inspection department shall be financially interested or employed by a business that is financially interested in the furnishing of labor, material, or appliances for the construction, alteration, or maintenance of any building within the local government's planning and development regulation jurisdiction or any part or system thereof, or in the making of plans or specifications therefor, unless he is the owner of the building. No member of an inspection department or other individual or an employee of a company contracting with a local government to conduct building inspections shall engage in any work that is inconsistent with his or her duties or with the interest of the local government, as determined by the local government. The local government must find a conflict of interest if any of the following is the case:



- (1) If the individual, company, or employee of a company contracting to perform building inspections for the local government has worked for the owner, developer, contractor, or project manager of the project to be inspected within the last two years.
- (2) If the individual, company, or employee of a company contracting to perform building inspections for the local government is closely related to the owner, developer, contractor, or project manager of the project to be inspected.
- (3) If the individual, company, or employee of a company contracting to perform building inspections for the local government has a financial or business interest in the project to be inspected.

The provisions of this section do not apply to a firefighter whose primary duties are fire suppression and rescue but who engages in some fire inspection activities as a secondary responsibility of the firefighter's employment as a firefighter, except no firefighter may inspect any work actually done, or materials or appliances supplied, by the firefighter or the firefighter's business within the preceding six years. (2019-111, s. 2.4; 2020-3, s. 4.33(a); 2020-25, s. 51(a), (b), (d).)

**§ 160D-1109. Failure to perform duties.**

- (a) If any member of an inspection department shall willfully fail to perform the duties required by law, or willfully shall improperly issue a building permit, or shall give a certificate of compliance without first making the inspections required by law, or willfully shall improperly give a certificate of compliance, the member shall be guilty of a Class 1 misdemeanor.
- (b) A member of the inspection department shall not be in violation of this section when the local government, its inspection department, or one of the inspectors accepted a signed written document of compliance with the North Carolina State Building Code or the North Carolina Residential Code for One- and Two-Family Dwellings from a licensed architect or licensed engineer in accordance with G.S. 160D-1104(d). (2019-111, s. 2.4; 2020-3, s. 4.33(a); 2020-25, s. 51(a), (b), (d).)

**§ 160D-1110. Building permits.**

- (a) Except as provided in subsection (c) of this section, no person shall commence or proceed with any of the following without first securing all permits required by the State Building Code and any other State or local laws applicable to any of the following activities:
  - (1) The construction, reconstruction, alteration, repair, movement to another site, removal, or demolition of any building or structure.
  - (2) The installation, extension, or general repair of any plumbing system except that in any one- or two-family dwelling unit a permit is not required for the connection of a water heater that is being replaced if (i) the work is performed by a person licensed under G.S. 87-21 who personally examines the work at completion and ensures that a leak test has been performed on the gas piping, and (ii) the energy use rate or thermal input is not greater than that of the water heater that is being replaced, there is no change in fuel, energy source, location, capacity, or routing or sizing of venting and piping, and the replacement is installed in accordance with the current edition of the State Building Code.
  - (3) The installation, extension, alteration, or general repair of any heating or cooling equipment system.
  - (4) The installation, extension, alteration, or general repair of any electrical wiring, devices, appliances, or equipment, except that in any one- or two-family dwelling unit a permit is not required for repair or replacement of electrical lighting fixtures or devices, such as receptacles and lighting switches, or for the connection of an existing branch circuit to an electric water heater that is being replaced if all of the following requirements are met:
    - a. With respect to electric water heaters, the replacement water heater is placed in the same location and is of the same or less capacity and electrical rating as the original.
    - b. With respect to electrical lighting fixtures and devices, the replacement is with a fixture or device having the same voltage and the same or less amperage.
    - c. The work is performed by a person licensed under G.S. 87-43.
    - d. The repair or replacement installation meets the current edition of the State Building Code, including the State Electrical Code.

However, a building permit is not required for the installation, maintenance, or replacement of any load control device or equipment by an electric power supplier, as defined in G.S. 62-133.8, or an electrical contractor contracted by the electric power supplier, so long as the work is subject to supervision by an electrical contractor licensed under Article 4 of Chapter 87 of the General Statutes. The electric power supplier shall provide such installation, maintenance, or replacement in accordance with (i) an activity or program ordered, authorized, or approved by the North Carolina Utilities Commission pursuant to G.S. 62-133.8 or G.S. 62-133.9 or (ii) a similar program undertaken by a municipal electric service provider, whether the installation, modification, or replacement is made before or after the point of delivery of electric service to the customer. The exemption under this subsection applies to all existing installations.

- (b) A building permit shall be in writing and shall contain a provision that the work done shall comply with the North Carolina State Building Code and all other applicable State and local laws. Nothing in this section requires a local government to review and approve residential building plans submitted to the local government pursuant to the North Carolina Residential Code, provided that the local government may review and approve the residential building plans as it deems necessary. If a local government chooses to review residential building plans for any structures subject to regulation under the North Carolina Residential Code for One- and Two-Family Dwellings, all initial reviews for the building permit must be performed within 15 business days of submission of the plans. A local government shall not require residential building plans for one- and two-family dwellings to be sealed by a licensed engineer or licensed architect unless required by the North Carolina State Building Code. No building permits shall be issued unless the plans and specifications are identified by the name and address of the author thereof, and, if the General Statutes of North Carolina require that plans for certain types of work be prepared only by a licensed architect or licensed engineer, no building permit shall be issued unless the plans and specifications bear the North Carolina seal of a licensed architect or of a licensed engineer. When any

provision of the General Statutes of North Carolina or of any ordinance or development or zoning regulation requires that work be done by a licensed specialty contractor of any kind, no building permit for the work shall be issued unless the work is to be performed by such a duly licensed contractor.

- (c) No permit issued under Article 9 or 9C of Chapter 143 of the General Statutes is required for any construction, installation, repair, replacement, or alteration performed in accordance with the current edition of the North Carolina State Building Code costing fifteen thousand dollars (\$15,000) or less in any single-family residence or farm building unless the work involves any of the following:
  - (1) The addition, repair, or replacement of load-bearing structures. However, no permit is required for replacement of windows, doors, exterior siding, or the pickets, railings, stair treads, and decking of porches and exterior decks.
  - (2) The addition or change in the design of plumbing. However, no permit is required for replacements otherwise meeting the requirements of this subsection that do not change size or capacity.
  - (3) The addition, replacement, or change in the design of heating, air-conditioning, or electrical wiring, devices, appliances, or equipment, other than like-kind replacement of electrical devices and lighting fixtures.
  - (4) The use of materials not permitted by the North Carolina Residential Code for One- and Two-Family Dwellings. The addition (excluding replacement) of roofing.
- (d) A local government shall not require more than one building permit for the complete installation or replacement of any natural gas, propane gas, or electrical appliance on an existing structure when the installation or replacement is performed by a person licensed under G.S. 87-21 or G.S. 87-43. The cost of the building permit for such work shall not exceed the cost of any one individual trade permit issued by that local government, nor shall the local government increase the costs of any fees to offset the loss of revenue caused by this provision.
- (e) No building permit shall be issued pursuant to subsection (a) of this section for any land-disturbing activity, as defined in G.S. 113A-52(6), or for any activity covered by G.S. 113A-57, unless an erosion and sedimentation control plan for the site of the activity or a tract of land including the site of the activity has been approved under the Sedimentation Pollution Control Act.
- (f) No building permit shall be issued pursuant to subsection (a) of this section for any land-disturbing activity that is subject to, but does not comply with, the requirements of G.S. 113A-71.
- (g) No building permit shall be issued pursuant to subdivision (1) of subsection (a) of this section where the cost of the work is thirty thousand dollars (\$30,000) or more, other than for improvements to an existing single-family residential dwelling unit as defined in G.S. 87-15.5(7) that the owner occupies as a residence, or for the addition of an accessory building or accessory structure as defined in the North Carolina Uniform Residential Building Code, the use of which is incidental to that residential dwelling unit, unless the name, physical and mailing address, telephone number, facsimile number, and electronic mail address of the lien agent designated by the owner pursuant to G.S. 44A-11.1(a) is conspicuously set forth in the permit or in an attachment thereto. The building permit may contain the lien agent's electronic mail address. The lien agent information for each permit issued pursuant to this subsection shall be maintained by the inspection department in the same manner and in the same location in which it maintains its record of building permits issued. Where the improvements to a real property leasehold are limited to the purchase, transportation, and setup of a manufactured home, as defined in G.S. 143-143.9(6), the purchase price of the manufactured home shall be excluded in determining whether the cost of the work is thirty thousand dollars (\$30,000) or more.
- (h) No local government may withhold a building permit or certificate of occupancy that otherwise would be eligible to be issued under this section to compel, with respect to another property or parcel, completion of work for a separate permit or compliance with land-use regulations under this Chapter unless otherwise authorized by law or unless the local government reasonably determines the existence of a public safety issue directly related to the issuance of a building permit or certificate of occupancy.
- (i) Violation of this section constitutes a Class 1 misdemeanor. (2019-111, s. 2.4; 2020-3, s. 4.33(a); 2020-25, ss. 30, 51(a), (b), (d).)

**§ 160D-1111. Expiration of building permits.**

A building permit issued pursuant to this Article expires by limitation of six months, or any lesser time fixed by ordinance, after the date of issuance if the work authorized by the permit has not been commenced. If, after commencement, the work is discontinued for a period of 12 months, the permit shall immediately expire. No work authorized by any building permit that has expired shall be performed until a new permit has been secured. (2019-111, s. 2.4; 2020-3, s. 4.33(a); 2020-25, s. 51(a), (b), (d); 2021-88, s. 1(g).)

**§ 160D-1112. Changes in work.**

After a building permit has been issued, no changes or deviations from the terms of the application, plans and specifications, or the permit, except where changes or deviations are clearly permissible under the State Building Code, shall be made until specific written approval of proposed changes or deviations has been obtained from the inspection department. (2019-111, s. 2.4; 2020-3, s. 4.33(a); 2020-25, s. 51(a), (b), (d).)

**§ 160D-1113. Inspections of work in progress.**

Subject to the limitation imposed by G.S. 160D-1104(d), as the work pursuant to a building permit progresses, local inspectors shall make as many inspections thereof as may be necessary to satisfy them that the work is being done according to the provisions of any applicable State and local laws and of the terms of the permit. In exercising this power, members of the inspection department have a right to enter on any premises within the jurisdiction of the department at all reasonable hours for the purposes of inspection or other enforcement action, upon presentation of proper credentials. If a building permit has been obtained by an owner exempt from licensure under G.S. 87-1(b)(2), no inspection shall be conducted without the owner being present, unless the plans for the building were drawn and sealed by an architect licensed pursuant to Chapter 83A of the General Statutes. (2019-111, s. 2.4; 2020-3, s. 4.33(a); 2020-25, ss. 31, 51(a), (b), (d).)





**§ 160D-1114. Appeals of stop orders.**

- (a) The owner or builder may appeal from a stop order involving alleged violation of the State Building Code or any approved local modification thereof to the North Carolina Commissioner of Insurance or his designee within a period of five days after the order is issued. Notice of appeal shall be given in writing to the Commissioner of Insurance or his designee, with a copy to the local inspector. The Commissioner of Insurance or his or her designee shall promptly conduct an investigation, and the appellant and the inspector shall be permitted to submit relevant evidence. The Commissioner of Insurance or his or her designee shall as expeditiously as possible provide a written statement of the decision setting forth the facts found, the decision reached, and the reasons for the decision. Pending the ruling by the Commissioner of Insurance or his or her designee on an appeal, no further work shall take place in violation of a stop order. In the event of dissatisfaction with the decision, the person affected shall have the following options:
- (1) Appealing to the Building Code Council.
  - (2) Appealing to the superior court as provided in G.S. 143-141.
- (b) The owner or builder may appeal against a stop order involving alleged violation of a local development regulation as provided in G.S. 160D-405. (2019-111, s. 2.4; 2020-3, s. 4.33(a); 2020-25, s. 51(a), (b), (d).)

**§ 160D-1115. Revocation of building permits.**

The appropriate inspector may revoke and require the return of any building permit by notifying the permit holder in writing stating the reason for the revocation. Building permits shall be revoked for any substantial departure from the approved application, plans, or specifications; for refusal or failure to comply with the requirements of any applicable State or local laws; or for false statements or misrepresentations made in securing the permit. Any building permit mistakenly issued in violation of an applicable State or local law may also be revoked. (2019-111, s. 2.4; 2020-3, s. 4.33(a); 2020-25, s. 51(a), (b), (d).)

**§ 160D-1116. Certificates of compliance; temporary certificates of occupancy.**

- (a) At the conclusion of all work done under a building permit, the appropriate inspector shall make a final inspection, and, if the completed work complies with all applicable State and local laws and with the terms of the permit, the inspector shall issue a certificate of compliance. Except as provided by subsection (b) of this section, no new building or part thereof may be occupied, no addition or enlargement of an existing building may be occupied, and no existing building that has been altered or moved may be occupied, until the inspection department has issued a certificate of compliance.
- (b) A temporary certificate of occupancy may be issued permitting occupancy for a stated period of time of either the entire building or of specified portions of the building if the inspector finds that the building may safely be occupied prior to its final completion. A permit holder may request and be issued a temporary certificate of occupancy if the conditions and requirements of the North Carolina State Building Code are met.
- (c) Any person who owns, leases, or controls a building and occupies or allows the occupancy of the building or a part of the building before a certificate of compliance or temporary certificate of occupancy has been issued pursuant to subsection (a) or (b) of this section is guilty of a Class 1 misdemeanor. (2019-111, s. 2.4; 2020-3, s. 4.33(a); 2020-25, ss. 32, 51(a), (b), (d).)

**§ 160D-1117. Periodic inspections.**

The inspection department may make periodic inspections, subject to the governing board's directions, for unsafe, unsanitary, or otherwise hazardous and unlawful conditions in buildings or structures within its planning and development regulation jurisdiction. In exercising this power, members of the department shall have a right to enter on any premises within the jurisdiction of the department at all reasonable hours for the purposes of inspection or other enforcement action, upon presentation of proper credentials. Inspections of dwellings shall follow the provisions of G.S. 160D-1207. Nothing in this section shall be construed to prohibit periodic inspections in accordance with the State fire prevention code or as otherwise required by State law. (2019-111, s. 2.4; 2020-3, s. 4.33(a); 2020-25, s. 51(a), (b), (d).)

**§ 160D-1118. Defects in buildings to be corrected.**

When a local inspector finds any defects in a building or finds that the building has not been constructed in accordance with the applicable State and local laws, or that a building because of its condition is dangerous or contains fire hazardous conditions, it shall be the inspector's duty to notify the owner or occupant of the building of its defects, hazardous conditions, or failure to comply with law. The owner or occupant shall each immediately remedy the defects, hazardous conditions, or violations of law in the property. (2019-111, s. 2.4; 2020-3, s. 4.33(a); 2020-25, s. 51(a), (b), (d).)

**§ 160D-1119. Unsafe buildings condemned.**

- (a) Designation of Unsafe Buildings. - Every building that shall appear to the inspector to be especially dangerous to life because of its liability to fire or because of bad condition of walls, overloaded floors, defective construction, decay, unsafe wiring or heating systems, inadequate means of egress, or other causes shall be held to be unsafe, and the inspector shall affix a notice of the dangerous character of the structure to a conspicuous place on the exterior wall of the building.
- (b) Nonresidential Building or Structure. - In addition to the authority granted in subsection (a) of this section, an inspector may declare a nonresidential building or structure within a community development target area to be unsafe if it meets all of the following conditions:
- (1) It appears to the inspector to be vacant or abandoned.
  - (2) It appears to the inspector to be in such dilapidated condition as to cause or contribute to blight, disease, vagrancy, or fire or safety hazard, to be a danger to children, or to tend to attract persons intent on criminal activities or other activities that would constitute a public nuisance.

- (c) Notice Posted on Structure. - If an inspector declares a nonresidential building or structure to be unsafe under subsection (b) of this section, the inspector must affix a notice of the unsafe character of the structure to a conspicuous place on the exterior wall of the building. For the purposes of this section, the term "community development target area" means an area that has characteristics of an urban progress zone under G.S. 143B-437.09, a "nonresidential redevelopment area" under G.S. 160A-503(10), or an area with similar characteristics designated by the governing board as being in special need of revitalization for the benefit and welfare of its citizens.
- (d) Applicability to Residential Structures. - A local government may expand subsections (b) and (c) of this section to apply to residential buildings by adopting an ordinance. Before adopting such an ordinance, a local government shall hold a legislative hearing with published notice as provided by G.S. 160D-601. (2019-111, s. 2.4; 2020-3, s. 4.33(a); 2020-25, s. 51(a), (b), (d).)

**§ 160D-1120. Removing notice from condemned building.**

If any person shall remove any notice that has been affixed to any building or structure by a local inspector of any local government and that states the dangerous character of the building or structure, that person shall be guilty of a Class 1 misdemeanor. (2019-111, s. 2.4; 2020-3, s. 4.33(a); 2020-25, s. 51(a), (b), (d).)

**§ 160D-1121. Action in event of failure to take corrective action.**

If the owner of a building or structure that has been condemned as unsafe pursuant to G.S. 160D-1119 fails to take prompt corrective action, the local inspector shall give written notice, by certified mail to the owner's last known address or by personal service, of all of the following:

- (1) That the building or structure is in a condition that appears to meet one or more of the following conditions:
  - a. Constitutes a fire or safety hazard.
  - b. Is dangerous to life, health, or other property.
  - c. Is likely to cause or contribute to blight, disease, vagrancy, or danger to children.
  - d. Has a tendency to attract persons intent on criminal activities or other activities that would constitute a public nuisance.
- (2) That an administrative hearing will be held before the inspector at a designated place and time, not later than 10 days after the date of the notice, at which time the owner will be entitled to be heard in person or by counsel and to present arguments and evidence pertaining to the matter.
- (3) That following the hearing, the inspector may issue such order to repair, close, vacate, or demolish the building or structure as appears appropriate.

If the name or whereabouts of the owner cannot, after due diligence, be discovered, the notice shall be considered properly and adequately served if a copy is posted on the outside of the building or structure in question at least 10 days prior to the hearing and a notice of the hearing is published in a newspaper having general circulation in the local government's area of jurisdiction at least once not later than one week prior to the hearing. (2019-111, s. 2.4; 2020-3, s. 4.33(a); 2020-25, ss. 33, 51(a), (b), (d).)

**§ 160D-1122. Order to take corrective action.**

If, upon a hearing held pursuant to the notice prescribed in G.S. 160D-1119, the inspector shall find that the building or structure is in a condition that constitutes a fire or safety hazard or renders it dangerous to life, health, or other property, the inspector shall make an order in writing, directed to the owner of such building or structure, requiring the owner to remedy the defective conditions by repairing, closing, vacating, or demolishing the building or structure or taking other necessary steps, within such period, not less than 60 days, as the inspector may prescribe, provided that where the inspector finds that there is imminent danger to life or other property, the inspector may order that corrective action be taken in such lesser period as may be feasible. (2019-111, s. 2.4; 2020-3, s. 4.33(a); 2020-25, s. 51(a), (b), (d).)

**§ 160D-1123. Appeal; finality of order if not appealed.**

Any owner who has received an order under G.S. 160D-1122 may appeal from the order to the governing board by giving notice of appeal in writing to the inspector and to the local government clerk within 10 days following issuance of the order. In the absence of an appeal, the order of the inspector is final. The governing board shall hear an appeal in accordance with G.S. 160D-406 and render a decision within a reasonable time. The governing board may affirm, modify and affirm, or revoke the order. (2019-111, s. 2.4; 2020-3, s. 4.33(a); 2020-25, ss. 34, 51(a), (b), (d).)

**§ 160D-1124. Failure to comply with order.**

If the owner of a building or structure fails to comply with an order issued pursuant to G.S. 160D-1122 from which no appeal has been taken or fails to comply with an order of the governing board following an appeal, the owner is guilty of a Class 1 misdemeanor. (2019-111, s. 2.4; 2020-3, s. 4.33(a); 2020-25, ss. 35, 51(a), (b), (d).)

**§ 160D-1125. Enforcement.**

- (a) Action Authorized. - Whenever any violation is denominated a misdemeanor under the provisions of this Article, the local government, either in addition to or in lieu of other remedies, may initiate any appropriate action or proceedings to prevent, restrain, correct, or abate the violation or to prevent the occupancy of the building or structure involved.
- (b) Removal of Building. - In the case of a building or structure declared unsafe under G.S. 160D-1119 or an ordinance adopted pursuant to G.S. 160D-1119, a local government may, in lieu of taking action under subsection (a) of this section, cause the building or structure to be removed or demolished. The amounts incurred by the local government in connection with the removal or demolition are a lien against the real property upon which the cost was incurred. The lien shall be filed, have the same priority, and be collected in the same manner as liens for special assessments

provided in Article 10 of Chapter 160A of the General Statutes. If the building or structure is removed or demolished by the local government, the local government shall sell the usable materials of the building and any personal property, fixtures, or appurtenances found in or attached to the building. The local government shall credit the proceeds of the sale against the cost of the removal or demolition. Any balance remaining from the sale shall be deposited with the clerk of superior court of the county where the property is located and shall be disbursed by the court to the person found to be entitled thereto by final order or decree of the court.

- (c) **Additional Lien.** - The amounts incurred by a local government in connection with the removal or demolition are also a lien against any other real property owned by the owner of the building or structure and located within the local government's planning and development regulation jurisdiction, and for cities without extraterritorial planning and development jurisdiction, within one mile of the city limits, except for the owner's primary residence. The provisions of subsection (b) of this section apply to this additional lien, except that this additional lien is inferior to all prior liens and shall be collected as a money judgment.
- (d) **Nonexclusive Remedy.** - Nothing in this section shall be construed to impair or limit the power of the local government to define and declare nuisances and to cause their removal or abatement by summary proceedings or otherwise. (2019-111, s. 2.4; 2020-3, s. 4.33(a); 2020-25, ss. 36, 51(a), (b), (d).)

**§ 160D-1126. Records and reports.**

The inspection department shall keep complete and accurate records in convenient form of all applications received, permits issued, inspections and reinspections made, defects found, certificates of compliance or occupancy granted, and all other work and activities of the department. These records shall be kept in the manner and for the periods prescribed by the Department of Natural and Cultural Resources. Periodic reports shall be submitted to the governing board and to the Commissioner of Insurance as they shall by ordinance, rule, or regulation require. (2019-111, s. 2.4; 2020-3, s. 4.33(a); 2020-25, s. 51(a), (b), (d).)

**§ 160D-1127. Appeals.**

Unless otherwise provided by law, appeals from any order, decision, or determination by a member of a local inspection department pertaining to the State Building Code or other State building laws shall be taken to the Commissioner of Insurance or the Commissioner's designee or other official specified in G.S. 143-139 by filing a written notice with the Commissioner and with the inspection department within a period of 10 days after the order, decision, or determination. Further appeals may be made to the State Building Code Council or to the courts as provided by law. (2019-111, s. 2.4; 2020-3, s. 4.33(a); 2020-25, s. 51(a), (b), (d).)

**§ 160D-1128. Fire limits.**

- (a) **County Fire Limits.** - A county may by ordinance establish and define fire limits in any area within the county and not within a city. The limits may include only business and industrial areas. Within any fire limits, no frame or wooden building or addition thereto may be erected, altered, repaired, or moved, either into the fire limits or from one place to another within the limits, except upon the permit of the inspection department and approval of the Commissioner of Insurance. The governing board may make additional regulations necessary for the prevention, extinguishment, or mitigation of fires within the fire limits.
- (b) **Municipal Fire Limits.** - The governing board of every incorporated city shall pass one or more ordinances establishing and defining fire limits, which shall include the principal business portions of the city and which shall be known as primary fire limits. In addition, the governing board may, in its discretion, establish and define one or more separate areas within the city as secondary fire limits.
- (c) **Restrictions Within Municipal Primary Fire Limits.** - Within the primary fire limits of any city, as established and defined by ordinance, no frame or wooden building or structure or addition thereto shall hereafter be erected, altered, repaired, or moved, either into the limits or from one place to another within the limits, except upon the permit of the local inspection department approved by the governing board and by the Commissioner of Insurance or the Commissioner's designee. The governing board may make additional regulations for the prevention, extinguishment, or mitigation of fires within the primary fire limits.
- (d) **Restrictions Within Municipal Secondary Fire Limits.** - Within any secondary fire limits of any city or town, as established and defined by ordinance, no frame or wooden building or structure or addition thereto shall be erected, altered, repaired, or moved, except in accordance with any rules and regulations established by ordinance of the areas.
- (e) **Failure to Establish Municipal Primary Fire Limits.** - If the governing board of any city shall fail or refuse to establish and define the primary fire limits of the city as required by law, after having such failure or refusal called to their attention in writing by the State Commissioner of Insurance, the Commissioner shall have the power to establish the limits upon making a determination that they are necessary and in the public interest. (2019-111, s. 2.4; 2020-3, s. 4.33(a); 2020-25, s. 51(a), (b), (d).)

**NC GENERAL STATUTES: CHAPTER 93B-15.1*****Licensure for Individuals with Military Training and Experience*****§ 93B-15.1. Licensure for individuals with military training and experience; proficiency examination; licensure by endorsement for military spouses; temporary license.**

- (a) Except as provided by subsection (a2) of this section, and notwithstanding any other provision of law, an occupational licensing board, or State agency licensing board, as defined in G.S. 93B-1, shall issue a license, certification, or registration to a military-trained applicant to allow the applicant to lawfully practice the applicant's occupation in this State if, upon application to an occupational licensing board or State agency licensing board, the military-trained applicant satisfies the following conditions:
- (1) Has been awarded a military occupational specialty and has done all of the following at a level that is substantially equivalent to or exceeds the requirements for licensure, certification, or registration of the occupational licensing board or State agency licensing board from which the applicant is seeking licensure, certification, or registration in this State: completed a military program of training, completed testing or equivalent training and experience, and performed in the occupational specialty.
  - (2) Has engaged in the active practice of the occupation for which the person is seeking a license, certification, or permit from the occupational licensing board or State agency licensing board in this State for at least two of the five years preceding the date of the application under this section.
  - (3) Has not committed any act in any jurisdiction that would have constituted grounds for refusal, suspension, or revocation of a license to practice that occupation in this State at the time the act was committed and has no pending complaints.
  - (4) Repealed by Session Laws 2017-28, s. 3, effective July 1, 2017, and applicable to applications submitted on or after that date.
- (a1) No later than 15 days following receipt of an application from a military-trained applicant, an occupational licensing board or State agency licensing board shall either issue a license, certification, or registration or notify an applicant when the applicant's military training or experience does not satisfy the requirements for licensure, certification, or registration and specify the criteria or requirements that the board determined that the applicant failed to meet and the basis for that determination. If a military-trained applicant has a pending complaint under subdivision (3) of subsection (a) of this section, an occupational licensing board or State agency licensing board shall notify the applicant no later than 15 days following the board receiving written notice of the disposition of the pending complaint.
- (a2) An occupational licensing board or State agency licensing board, as defined in G.S. 93B-1, shall issue a license, certification, or registration to a military-trained applicant to allow the applicant to lawfully practice the applicant's occupation in this State if the military-trained applicant, upon application to the occupational licensing board or State agency licensing board, satisfies the following conditions:
- (1) Presents official, notarized documentation, such as a U.S. Department of Defense Form 214 (DD-214), or similar substantiation, attesting to the applicant's military occupational specialty certification and experience in an occupational field within the board's purview; and
  - (2) Passes a proficiency examination offered by the board to military-trained applicants in lieu of satisfying the conditions set forth in subsection (a) of this section; however, if an applicant fails the proficiency examination, then the applicant may be required by the board to satisfy those conditions.

In any case where a proficiency examination is not offered routinely by an occupational licensing board or State agency licensing board, the board shall design a fair proficiency examination for military-trained applicants to obtain licensure, certification, or registration under this section. If G.S. 93B-15.1 Page 2 a proficiency examination is offered routinely by an occupational licensing board or State agency licensing board, that examination shall satisfy the requirements of this section.

- (b) Notwithstanding any other provision of law, an occupational licensing board or State agency licensing board, as defined in G.S. 93B-1, shall issue a license, certification, or registration to a military spouse to allow the military spouse to lawfully practice the military spouse's occupation in this State if, upon application to an occupational licensing board or State agency licensing board, the military spouse satisfies the following conditions:
- (1) Holds a current license, certification, or registration from another jurisdiction, and that jurisdiction's requirements for licensure, certification, or registration are substantially equivalent to or exceed the requirements for licensure, certification, or registration of the occupational licensing board or State agency licensing board for which the applicant is seeking licensure, certification, or registration in this State.
  - (2) Can demonstrate competency in the occupation through methods as determined by the Board, such as having completed continuing education units or having had recent experience for at least two of the five years preceding the date of the application under this section.
  - (3) Has not committed any act in any jurisdiction that would have constituted grounds for refusal, suspension, or revocation of a license to practice that occupation in this State at the time the act was committed.
  - (4) Is in good standing; has not been disciplined by the agency that had jurisdiction to issue the license, certification, or permit; and has no pending complaints.
  - (5) Repealed by Session Laws 2017-28, s. 3, effective July 1, 2017, and applicable to applications submitted on or after that date.
- (b1) No later than 15 days following receipt of an application from a military spouse, an occupational licensing board or State agency licensing board shall either issue a license, certification, or registration or notify an applicant when the applicant's training or experience does not satisfy the requirements for licensure, certification, or registration and specify the criteria or requirements that the board determined that the applicant failed to meet and the basis for that determination. If an applicant who is a military spouse has a pending complaint under subdivision (4) of

- subsection (b) of this section, an occupational licensing board or State agency licensing board shall notify the applicant no later than 15 days following the board receiving written notice of the disposition of the pending complaint.
- (c) All relevant experience of a military service member in the discharge of official duties or, for a military spouse, all relevant experience, including full-time and part-time experience, regardless of whether in a paid or volunteer capacity, shall be credited in the calculation of years of practice in an occupation as required under subsection (a) or (b) of this section.
- (c1) Each occupational licensing board or State agency licensing board shall publish on its Web site all of the following:
- (1) A document that lists the specific criteria or requirements for licensure, registration, or certification by the board, with a description of the criteria or requirements that are satisfied by military training or experience as provided in this section, and any necessary documentation needed for obtaining the credit or satisfying the requirement.
  - (2) A document that includes a summary of the opportunities available to veterans and military spouses under this section.
- (c2) The Secretary of the Department of Military and Veterans Affairs shall publish on the Department's Web site the information required under subsection (c1) of this section. G.S. 93B-15.1
- (d) A nonresident licensed, certified, or registered under this section shall be entitled to the same rights and subject to the same obligations as required of a resident licensed, certified, or registered by an occupational licensing board or State agency licensing board in this State.
- (e) Nothing in this section shall be construed to apply to the practice of law as regulated under Chapter 84 of the General Statutes.
- (f) An occupational licensing board or State agency licensing board shall issue a temporary practice permit to a military-trained applicant or military spouse licensed, certified, or registered in another jurisdiction while the military-trained applicant or military spouse is satisfying the requirements for licensure under subsection (a) or (b) of this section no later than 15 days following receipt of an application, if that jurisdiction has licensure, certification, or registration standards substantially equivalent to the standards for licensure, certification, or registration of an occupational licensing board or State agency licensing board in this State. The temporary practice permit shall be issued using the same information as provided by the applicant in the licensure application and remain valid for the later of one year or the required renewal date for the occupation the temporary practice permit was issued for or until a license, certification, or registration is granted by the occupational licensing board or State agency licensing board. A temporary practice permit may be denied or revoked for a pending complaint after notice is provided to the military-trained applicant or military spouse as set forth under subsection (a1) or (b1) of this section.
- (g) An occupational licensing board or State agency licensing board may adopt rules necessary to implement this section.
- (h) Nothing in this section shall be construed to prohibit a military-trained applicant or military spouse from proceeding under the existing licensure, certification, or registration requirements established by an occupational licensing board or State agency licensing board in this State.
- (i) In addition to the provisions for licensure provided by this section, a local board of education may request a three-year limited license for a military spouse who holds a current teaching license in another jurisdiction pursuant to G.S. 115C-270.20(a)(4a). The State Board of Education shall report the information specified in G.S. 93B-2(a)(9c) and (9d) in accordance with G.S. 93B-2.
- (j) For the purposes of this section, the North Carolina Medical Board shall not be considered an occupational licensing board or State agency licensing board.
- (k) An occupational licensing board or State agency licensing board shall not charge a military-trained applicant or a military spouse an initial application fee for a license, certification, registration, or temporary practice permit issued pursuant to this section. Nothing in this subsection shall be construed to prohibit an occupational licensing board or State agency licensing board from charging its ordinary fee for a renewal application or prohibit a third party from charging actual costs for a service such as a background check. (2012-196, s. 1; 2014-67, s. 1; 2015-143, s. 1; 2015-241, s. 24.1(r); 2015-268, s. 7.3(a); 2017-28, s. 3; 2017-189, s. 6(a); 2019-71, s. 2.3; 2020-87, s. 1.)

---

## NC GENERAL STATUTES: CHAPTER 143-138 (B16)

---

### *North Carolina State Building Code: Permit Exceptions*

#### § 143-138. North Carolina State Building Code

- (b16) Exclusion for Electrical Devices and Lighting Fixtures. – No permit shall be required under the Code or any local variant approved under subsection (e) of this section for the repair or replacement of dishwashers, disposals, water heaters, electrical devices, or lighting fixtures in residential or commercial structures, provided that all of the following apply:
- (1) The repair or replacement does not require the addition or relocation of electrical wiring.
  - (2) The work is performed by a person or employee of a company licensed under G.S. 87-43.
  - (3) The repair or replacement is performed in accordance with the current edition of the North Carolina State Building Code.

## EXAMINATION APPLICATION CHECKLIST

**Use the following check list to complete your Exam Application. Ensure all applicable documents listed are submitted with your Application.**

Further details on all exam application requirements can be found within this handbook; it is highly recommended that all applicants review this handbook in its entirety prior to applying for and taking the exam.

- Employer Statement Form** (forms enclosed) verifying experience hours required for the classification chosen as defined in Rule .0202 of Title 21 NCAC18B (attached).
- 2 Character Statement Forms** (forms enclosed) from at least two persons who are knowledgeable of and can attest to the applicants' good character.
- (*Unlimited Classification Applicants ONLY*)  
**2 Supervise & Direct Statement Forms** (forms enclosed) from at least two persons who are knowledgeable of and can attest to the applicants' ability to supervise and direct all electrical work.
- Exam Fee of \$125.00.** Payment may be made by Check, Money Order or Credit Card. Make checks payable to NCBEEC.

*If you have any questions or need assistance with your application documents, contact our office at (919) 733-9042.*

### NOTICE OF PROCESSING FEE FOR SUBMITTAL OF BAD CHECK

Pursuant to Rule .0107 of Title 21, Chapter 18B, of the North Carolina Administrative Code, any person, partnership, firm, or corporation submitting a check to the Board that is subsequently returned because of insufficient funds or no account at a bank will be charged a processing fee of \$25.00 for such a check; and, until the payer has made the check good and paid the \$25.00 processing fee, the payer will not be eligible to take an examination, review an examination, obtain a license or have a license, renewed. Payment for making good such bad check and for the \$25.00 processing fee must be in the form of a cashier's check or money order payable to the "NCBEEC".

### CRIMINAL BACKGROUND AND HISTORY NOTICE

Pursuant to Session Law 2019-91, all licensing boards must to include a reference to the appeal process in any orders denying licensure based on criminal convictions. The Board may conduct a formal criminal or disciplinary history check. Answering "yes" to any of these questions or having a conviction, disciplinary or adverse employment action is not automatically a basis for denial of licensure.

When an applicant has a criminal conviction, the Board will consider:

- (1) The level and seriousness of the crime.
- (2) The date of the crime.
- (3) The age of the person at the time of the crime.
- (4) The circumstances surrounding the commission of the crime, if known.
- (5) The nexus between the criminal conduct and the prospective duties of the applicant as a licensee.
- (6) The prison, jail, probation, parole, rehabilitation, and employment records of the applicant since the date the crime was committed.
  - a. The completion of, or active participation in, rehabilitative drug or alcohol treatment.
  - b. A Certificate of Relief granted pursuant to North Carolina Gen. Stat. § 15A-173.2.
- (7) The subsequent commission of a crime by the applicant.
- (8) Any affidavits or other written documents, including character references.

If Board staff is unable to approve an application, the applicant has the right to request to have that application heard by the members of the Board. Any such request should be submitted in writing to the Board's Executive Director. The Board will conduct that hearing pursuant to the North Carolina Administrative Procedure Act and the Board's own hearing rules. As a result of the evidence presented at that hearing and considering the considerations outlined above, the Board may refuse to grant or may condition a license if it finds any of the grounds for doing so under North Carolina Gen. Stat. § 90-85.38(a).

If the applicant wishes to appeal the Board's final decision, the applicant may seek review of the decision by filing a petition for judicial review in the Superior Court pursuant to Article 4 of the Administrative Procedure Act, North Carolina Gen. Stat. § 150B-43 et seq.





**APPLICATION FOR EXAMINATION**

**SUBMIT DOCUMENTS TO:**

Mail: NCBEEC, 505 N. Greenfield Pkwy,  
 Suite 100, Garner, NC 27529

Email: Office@ncbeec.org

Fax: (800) 691-8399

**EXAMINATION FEE: \$125.00 (ALL CLASSIFICATIONS; INCLUDES APPLICATION AND EXAMINATION. APPLICATION FEE IS NON-REFUNDABLE.)**

1. CLASSIFICATION OF EXAMINATION (CHECK ONE CLASSIFICATION):

- LIMITED     INTERMEDIATE     UNLIMITED     SP-SFD     SP-FA/LV  
 SP-PH     SP-EL     SP-WP     SP-ES     SP-SP

2. NAME \_\_\_\_\_ SOCIAL SECURITY # \_\_\_\_\_  
(FIRST) (MIDDLE) (LAST)

ADDRESS \_\_\_\_\_ ZIP CODE \_\_\_\_\_ COUNTY \_\_\_\_\_  
(STREET OR P.O. BOX) (CITY) (STATE)

PHONE \_\_\_\_\_ EMAIL \_\_\_\_\_ DATE OF BIRTH \_\_\_\_\_  
(AREA CODE)

3. HAVE YOU EVER BEEN APPROVED TO TAKE AN EXAMINATION CONDUCTED BY THIS BOARD FOR AN ELECTRICAL CONTRACTING LICENSE?

\_\_\_\_\_ WHICH CLASSIFICATION? \_\_\_\_\_

4. PRESENT EMPLOYER COMPANY NAME \_\_\_\_\_  
(LIST UNEMPLOYED OR N/A IF NO EMPLOYER)

EMPLOYER MAILING ADDRESS \_\_\_\_\_  
(STREET OR P.O. BOX) (CITY) (STATE) (ZIP CODE)

EMPLOYER PHONE \_\_\_\_\_ CURRENT POSITION \_\_\_\_\_ HIRE DATE \_\_\_\_\_  
(AREA CODE)

*UNDER STATE LAW, AN APPLICANT IS NOT REQUIRED TO INCLUDE A REFERENCE TO OR INFORMATION CONCERNING ANY ARREST, CHARGE OR CONVICTION THAT HAVE BEEN EXPUNGED*

5. A. HAVE YOU BEEN CONVICTED OF A **MISDEMEANOR** IN THE **PAST 3 YEARS?** (EXCLUDING MINOR TRAFFIC VIOLATIONS)     YES     NO  
 B. HAVE YOU EVER BEEN CONVICTED OF A **FELONY?**     YES     NO

IF YES TO EITHER, EXPLAIN ON REVERSE SIDE OF THIS FORM AND PROVIDE A COMPLETE COPY OF THE COURT JUDGMENT. IF A COPY OF THE COURT JUDGMENT WAS PREVIOUSLY SUBMITTED, INITIAL HERE AND DO NOT RE-SUBMIT. \_\_\_\_\_

6. **METHOD OF PAYMENT**     CHECK/MONEY ORDER (PAYABLE TO NCBEEC)     CREDIT CARD

CARD NUMBER \_\_\_\_\_ EXPIRATION DATE \_\_\_\_\_ SECURITY CODE \_\_\_\_\_

CARD NAME \_\_\_\_\_ BILLING ADDRESS \_\_\_\_\_ ZIP \_\_\_\_\_

**BY SIGNING THE APPLICANT AUTHORIZES THE BOARD TO RESEARCH AND VERIFY THE INFORMATION SUBMITTED CONCERNING THIS APPLICATION.**

**SIGNATURE OF APPLICANT** \_\_\_\_\_ **DATE** \_\_\_\_\_

(FOR BOARD USE ONLY)

APPROVED BY \_\_\_\_\_ DATE \_\_\_\_\_ FEE \_\_\_\_\_ BATCH \_\_\_\_\_

EXPERIENCE \_\_\_\_\_ S&D \_\_\_\_\_ CHARACTER \_\_\_\_\_ BACKGROUND \_\_\_\_\_



SECTION .0200 – EXAMINATIONS.0201 REQUIREMENTS FOR ALL EXAMINATION APPLICANTS

- (a) To take an examination in any electrical contracting license classification, the applicant must:
- 1) be at least 18 years of age;
  - 2) submit the required duly filed application as defined in Rule .0210;
  - 3) submit with the application written statements from at least two persons attesting to the applicant's good character; and
  - 4) meet any other requirements set out in Paragraph (b) of this Rule.
- (b) Examination applicants must meet the following requirements for the specified license classifications:
- 1) Limited classification. An applicant must have at least 3,000 hours of experience, as defined in Rule .0202 of this Section, of which at least 2,000 hours shall be primary experience. The balance of experience may be primary, secondary or both.
  - 2) Intermediate classification. An applicant must have at least 5,750 hours of experience, as defined in Rule .0202 of this Section, of which at least 5,000 hours shall be primary experience. The balance of experience may be primary, secondary or both.
  - 3) Unlimited classification. An applicant must:
    - A) have at least 9,000 hours of experience, as defined in Rule .0202 of this Section, of which at least 8,000 hours shall be primary experience. The balance of experience may be primary, secondary or both, and
    - B) submit with the application written statements from at least two persons, who are knowledgeable of the applicant's electrical experience, attesting to the applicant's ability to supervise and direct all electrical wiring or electrical installation work done by an electrical contracting business in the unlimited classification.
  - 4) Single family detached residential dwelling (SP-SFD) classification. An applicant must have at least 3,000 hours of experience, as defined in Rule .0202 of this Section, of which at least 2,000 hours shall be primary experience. The balance of experience may be primary, secondary or both.
  - 5) Special restricted fire alarm/low voltage (FALV) classification. An applicant must have at least 3,000 hours of experience, as defined in Rule .0202 of this Section, of which at least 2,000 hours shall be primary experience. The balance of experience may be primary, secondary or both. An applicant in this classification may also receive creditable experience for service in any of the capacities listed in Rule .0202 that the applicant gained in the low voltage field.
  - 6) Special restricted elevator (SP-EL) classification. An applicant must:
    - A) have at least 3,000 hours of experience, as defined in Rule .0202 of this Section, of which at least 2,000 hours shall be primary experience. The balance of experience may be primary, secondary or both. An applicant in this classification may also receive creditable experience for service in any of the capacities listed in Rule .0202 that the applicant gained in the elevator field, and
    - B) include on the application information verifying that the applicant is primarily engaged in or is regularly employed by and will be the listed qualified individual, for a firm that is primarily engaged in, a lawful elevator business in this State.
  - 7) Special restricted plumbing and heating (SP-PH) classification. An applicant must:
    - A) have at least 3,000 hours of experience, as defined in Rule .0202 of this Section, of which at least 2,000 hours shall be primary experience. The balance of experience may be primary, secondary or both. An applicant in this classification may also receive creditable experience for service in any of the capacities listed in Rule .0202 that the applicant gained in the plumbing, heating, or air conditioning field, and
    - B) include on the application information verifying that the applicant is primarily engaged in or is regularly employed by and will be the listed qualified individual, for a firm that is primarily engaged in, a lawful plumbing, heating, or air conditioning business in this State.
  - 8) Special restricted ground water pump (SP-WP) classification. An applicant must:
    - A) have at least 3,000 hours of experience, as defined in Rule .0202 of this Section, of which at least 2,000 hours shall be primary experience. The balance of experience may be primary, secondary or both. An applicant in this classification may also receive creditable experience for service in any of the capacities listed in Rule .0202 that applicant gained in the ground water pump field, and
    - B) include on the application information verifying that the applicant is primarily engaged in or is regularly employed by and will be the listed qualified individual for a firm that is primarily engaged in, a lawful ground water pump business in this State.
  - 9) Special restricted electric sign (SP-ES) classification. An applicant must:
    - A) have at least 3,000 hours of experience, as defined in Rule .0202 of this Section, of which at least 2,000 hours shall be primary experience. The balance of experience may be primary, secondary or both. An applicant in this classification may also receive creditable experience in any of the capacities listed in Rule .0202 that the applicant gained in the electric sign field, and
    - B) include on the application information verifying that the applicant is primarily engaged in or is regularly employed by and will be the listed qualified individual for a firm that is primarily engaged in, a lawful electric sign business in this State.
  - 10) Special restricted swimming pool (SP-SP) classification. An applicant must:
    - A) have at least 3,000 hours of experience, as defined in Rule .0202 of this Section, of which at least 2,000 hours shall be primary experience. The balance of experience may be primary, secondary or both. An applicant in this classification may also receive creditable experience for service in any of the capacities listed in Rule .0202 that the applicant gained in the swimming pool field, and
    - B) include on the application information verifying that the applicant is primarily engaged in or is regularly employed by and will be the listed qualified individual for a firm that is primarily engaged in, a lawful swimming pool business in this State.

History Note: Authority G.S. 87-42; 87-43.3; 87-43.4; 87-44; Eff. October 1, 1988. Amended Eff. October 1, 2022; October 1, 2017; January 1, 2010; March 1, 1999; February 1, 1990.





0202 EXPERIENCE

(a) **Primary.** As used in this Chapter, primary experience means working experience gained by the applicant while engaged directly in the installation of electrical wiring and equipment governed by the National Electrical Code or work activities directly related thereto. Examples of the capacity in which a person may work in gaining primary experience and the percentages for creditable primary experience are as follows:

PRIMARY CAPACITY EXAMPLES	% OF HOURS ACCEPTED
1) Journeyman electrician or electrician mechanic, both meaning the same; .....	100
2) Electrical foreman; .....	100
3) Electrical general foreman;.....	100
4) Electrical superintendent;.....	100
5) Electrical general superintendent;.....	100
6) Estimator for licensed electrical contractor;.....	100
7) Electrical inspector recognized as such by the State Department of Insurance;.....	100
8) Time spent by a professional engineer who is responsible for follow-up project supervision, beyond the point of delivery, in electrical engineering, design consulting;.....	100
9) Full-time instructor teaching National Electrical Code, NFPA 72 and related electrical courses at a college, university, community college, technical institute, high school or vocational school;.....	80
10) Maintenance journeyman electrician or electrician mechanic employed in a full-time electrical maintenance department;.....	100
11) Time actually spent in electrical maintenance by a maintenance journeyman electrician or electrician mechanic regularly employed in other than a full-time electrical maintenance department;.....	100
12) Military person holding an electrician rating or rank of at least E-4 who is engaged in land-based electrical installations similar or equivalent to work performed by an electrical contractor;.....	100
13) Time actually spent in part-time or incidental work in any primary experience category;.....	100
14) Time actually spent installing or maintaining fire alarm/low voltage systems;.....	100
15) Time as a holder of NICET certification on NFPA 72 Level I, II, III or IV applicable to Fire Alarm and Low Voltage only.....	100

In calculating accumulative primary experience, a total of 2,000 hours shall equal one full-time creditable year. The total number of creditable years shall be calculated by dividing the total hours of primary experience by 2,000. Example: Applicant has worked in primary capacity for a total of 7,200 hours of primary experience.  $7,200 / 2,000 = 3.6$  years creditable primary work experience.

(b) **Secondary.** As used in this Chapter, secondary experience means working experience gained while engaged in work or training that is related to the installation of electrical wiring and equipment governed by the National Electrical Code. Examples of the type of work or training in which a person may engage to gain creditable secondary experience and the percentages for creditable secondary experience are as follows:

SECONDARY CAPACITY EXAMPLES	% OF HOURS ACCEPTED
1) Apprentice electrician training in an apprentice program approved by the NC Community College System;.....	100
2) Time spent as an apprentice electrician or helper other than as described in subparagraphs (1) and (3) of this paragraph;.....	80
3) Time actually spent in electrical maintenance by a maintenance apprentice or electrician helper regularly employed in other than a full-time electrical maintenance department;.....	80
4) Student satisfactorily completing National Electrical Code and related electrical courses at a college, university, community college, technical institute, high school, or vocational school;.....	50
5) Time spent by a professional engineer who is not responsible for follow-up project supervision, beyond the point of delivery, in electrical engineering, design, or consulting;.....	50
6) Electrical construction design under the supervision of a professional engineer;.....	50
7) Sales representative for an electrical wholesaler, distributor, or manufacturer;.....	20
8) Appliance service and repair;.....	20
9) Electric utility lineman; and.....	10
10) Electric utility serviceman.....	20

In calculating accumulative secondary experience, a total of 2,000 hours shall equal one full-time creditable year. The total number of creditable years shall be calculated by applying the percentage for creditable secondary experience and dividing the remainder hours by 2,000. Example: Applicant has 1,000 hours of work experience as a helper or regular apprentice and 2,200 hours of experience while enrolled in an approved apprentice training program: 1,000 hours at 80 percent = 800 hours secondary experience; 2,200 hours at 100 percent = 2,200 hours secondary experience;  $800 + 2,200 / 2,000 = 1.5$  years creditable secondary experience

(c) **Other Experience.** The Board shall approve other experience that it finds to be equivalent or similar to the primary or secondary experience defined in this Rule.

History Note: Authority G.S. 87-42; 87-43.3; 87-43.4; Eff. October 1, 1988. Amended Eff. October 1, 2017; January 1, 2010; March 1, 1999.





## EMPLOYER STATEMENT FORM

**ELECTRICAL EXPERIENCE SHOULD BE STATED ON THIS FORM.** This form is to be completed the applicants past or present employer or employer representative under whom their electrical experience was gained. **Refer to Board rule “.0202 Experience” when completing this form.** The Board reserves the right to contact the Employer/Employer Representative and review all employment records in making a final determination of an applicant’s experience.

This document must be submitted with your Examination Application. Separate forms should be used for each employer. Altered forms will not be accepted. **Applicants cannot verify their own experience.**

**Job titles / full-time / etc. listed as a capacity below WILL NOT BE ACCEPTED. Acceptable experience capacities are in rule .0202 “Experience”.**

This is to certify that \_\_\_\_\_ is/was employed by this firm in the following capacity/capacities and gained the stated experience while working in said capacity:

**A) SECONDARY EXPERIENCE:** Working experience gained while engaged in work or training that is related to the installation of electrical wiring and equipment governed by the National Electrical Code or work activities directly related thereto. *(Examples: Helper or Apprentice. Enter dates of employment, capacity held and total hours of experience gained while in that capacity.)*

BEGIN DATE OF EXPERIENCE: \_\_\_\_\_ END DATE OF EXPERIENCE: \_\_\_\_\_

CAPACITY: \_\_\_\_\_ TOTAL HOURS EXPERIENCE: \_\_\_\_\_

**B) PRIMARY EXPERIENCE:** Working experience gained by the applicant while engaged directly in the installation of electrical wiring and equipment governed by the National Electrical Code or work activities directly related thereto. *(Examples: Journeyman or Electrician Mechanic. Enter time period experience was gained, capacity held and total hours of experience.)*

BEGIN DATE OF EXPERIENCE: \_\_\_\_\_ END DATE OF EXPERIENCE: \_\_\_\_\_

CAPACITY: \_\_\_\_\_ TOTAL HOURS EXPERIENCE: \_\_\_\_\_

**C) OTHER EXPERIENCE:** *(Enter dates of employment, capacity held and total hours of experience gained while in that capacity.)*

BEGIN DATE OF EXPERIENCE: \_\_\_\_\_ END DATE OF EXPERIENCE: \_\_\_\_\_

CAPACITY: \_\_\_\_\_ TOTAL HOURS EXPERIENCE: \_\_\_\_\_

Please check one of the following that best describes this applicant’s character:       GOOD       NOT GOOD       NO OPINION

Other Comments: \_\_\_\_\_

Employer Company Name: \_\_\_\_\_

Employer Address: \_\_\_\_\_  
(STREET / P.O. BOX) (CITY) (STATE) (ZIP CODE)

Phone: \_\_\_\_\_ Email Address: \_\_\_\_\_  
(AREA CODE)

Employer/Representative Signature: \_\_\_\_\_ Title: \_\_\_\_\_

Employer/Representative Printed Name: \_\_\_\_\_ Date Signed: \_\_\_\_\_

STATE OF \_\_\_\_\_ COUNTY OF \_\_\_\_\_

I, a notary public of the aforesaid state and county, certify that the employer/representative whose signature appears above, personally appeared before me, and signed the foregoing document.

Witness my hand and official seal, this \_\_\_\_\_ day of \_\_\_\_\_, \_\_\_\_\_ (SEAL)

Notary Printed Name \_\_\_\_\_ Notary Signature \_\_\_\_\_

My Commission Expires \_\_\_\_\_

(BOARD USE ONLY)

APPROVED BY: \_\_\_\_\_ DATE: \_\_\_\_\_





---

---

## CHARACTER STATEMENT FORM

---

---

**THIS FORM REFERS TO THE APPLICANTS CHARACTER.** TWO (2) WRITTEN STATEMENTS FROM AT LEAST TWO (2) INDIVIDUALS ATTESTING TO THE APPLICANT'S GOOD CHARACTER ARE REQUIRED. EXAMPLES OF ACCEPTABLE CHARACTER WITNESSES INCLUDE BUT ARE NOT LIMITED TO: CO-WORKERS, EMPLOYERS, PROFESSIONAL ASSOCIATES, ETC.

This is to certify that I have known \_\_\_\_\_ for approximately \_\_\_\_\_ years and that in my opinion, they are of good character.

Signed this \_\_\_\_\_ day of \_\_\_\_\_, \_\_\_\_\_.

WITNESS SIGNATURE: \_\_\_\_\_

PRINTED NAME: \_\_\_\_\_

TITLE: \_\_\_\_\_

COMPANY: \_\_\_\_\_

ADDRESS: \_\_\_\_\_  
(STREET / P.O. BOX)

\_\_\_\_\_  
(CITY / STATE / ZIP CODE)

PHONE: \_\_\_\_\_  
(AREA CODE)

EMAIL: \_\_\_\_\_

---

(BOARD USE ONLY)

APPROVED BY: \_\_\_\_\_ DATE: \_\_\_\_\_





## CHARACTER STATEMENT FORM

THIS FORM REFERS TO THE APPLICANTS CHARACTER. TWO (2) WRITTEN STATEMENTS FROM AT LEAST TWO (2) INDIVIDUALS ATTESTING TO THE APPLICANT'S GOOD CHARACTER ARE REQUIRED. EXAMPLES OF ACCEPTABLE CHARACTER WITNESSES INCLUDE BUT ARE NOT LIMITED TO: CO-WORKERS, EMPLOYERS, PROFESSIONAL ASSOCIATES, ETC.

This is to certify that I have known \_\_\_\_\_ for approximately \_\_\_\_\_ years and that in my opinion, they are of good character.

Signed this \_\_\_\_\_ day of \_\_\_\_\_, \_\_\_\_\_.

WITNESS SIGNATURE: \_\_\_\_\_

PRINTED NAME: \_\_\_\_\_

TITLE: \_\_\_\_\_

COMPANY: \_\_\_\_\_

ADDRESS: \_\_\_\_\_  
(STREET / P.O. BOX)

\_\_\_\_\_  
(CITY / STATE / ZIP CODE)

PHONE: \_\_\_\_\_  
(AREA CODE)

EMAIL: \_\_\_\_\_

(BOARD USE ONLY)

APPROVED BY: \_\_\_\_\_ DATE: \_\_\_\_\_





## SUPERVISE & DIRECT STATEMENT FORM

REQUIRED FOR THE UNLIMITED CLASSIFICATION ONLY.

**THIS FORM REFERS TO THE APPLICANT'S SUPERVISORY ABILITIES.** TWO (2) WRITTEN STATEMENTS FROM AT LEAST TWO (2) PERSONS WHO ARE KNOWLEDGABLE OF THE APPLICANT'S ABILITY TO SUPERVISE AND DIRECT ALL ELECTRICAL WIRING AND ELECTRICAL INSTALLATION WORK DONE BY AN ELECTRICAL CONTRACTING BUSINESS ARE REQUIRED.

THIS FORM MAY ALSO BE USED FOR CHARACTER REFERENCE. EXAMPLES OF ACCEPTABLE WITNESSES INCLUDE BUT ARE NOT LIMITED TO: CO- WORKERS, EMPLOYERS, PROFESSIONAL ASSOCIATES, ETC.

This is to certify that I have known \_\_\_\_\_ for approximately \_\_\_\_ years; that I am knowledgeable of their electrical experience; and that in my opinion they have the ability to satisfactorily supervise and direct all electrical wiring and electrical installation work performed by an electrical contracting business in the Unlimited classification.

Please check one of the following that best describes your opinion of the applicant's character:

GOOD                       NOT GOOD                       NO OPINION

Signed this \_\_\_\_\_ day of \_\_\_\_\_, \_\_\_\_\_.

WITNESS SIGNATURE: \_\_\_\_\_

PRINTED NAME: \_\_\_\_\_

TITLE: \_\_\_\_\_

COMPANY: \_\_\_\_\_

ADDRESS: \_\_\_\_\_  
(STREET / P.O. BOX)

\_\_\_\_\_  
(CITY / STATE / ZIP CODE)

PHONE: \_\_\_\_\_  
(AREA CODE)

EMAIL: \_\_\_\_\_

*(BOARD USE ONLY)*

APPROVED BY: \_\_\_\_\_ DATE: \_\_\_\_\_





## SUPERVISE & DIRECT STATEMENT FORM

REQUIRED FOR THE UNLIMITED CLASSIFICATION ONLY.

THIS FORM REFERS TO THE APPLICANT'S SUPERVISORY ABILITIES. TWO (2) WRITTEN STATEMENTS FROM AT LEAST TWO (2) PERSONS WHO ARE KNOWLEDGABLE OF THE APPLICANT'S ABILITY TO SUPERVISE AND DIRECT ALL ELECTRICAL WIRING AND ELECTRICAL INSTALLATION WORK DONE BY AN ELECTRICAL CONTRACTING BUSINESS ARE REQUIRED.

THIS FORM MAY ALSO BE USED FOR CHARACTER REFERENCE. EXAMPLES OF ACCEPTABLE WITNESSES INCLUDE BUT ARE NOT LIMITED TO: CO- WORKERS, EMPLOYERS, PROFESSIONAL ASSOCIATES, ETC.

This is to certify that I have known \_\_\_\_\_ for approximately \_\_\_\_ years; that I am knowledgeable of their electrical experience; and that in my opinion they have the ability to satisfactorily supervise and direct all electrical wiring and electrical installation work performed by an electrical contracting business in the Unlimited classification.

Please check one of the following that best describes your opinion of the applicant's character:

GOOD                       NOT GOOD                       NO OPINION

Signed this \_\_\_\_\_ day of \_\_\_\_\_, \_\_\_\_\_.

WITNESS SIGNATURE: \_\_\_\_\_

PRINTED NAME: \_\_\_\_\_

TITLE: \_\_\_\_\_

COMPANY: \_\_\_\_\_

ADDRESS: \_\_\_\_\_  
(STREET / P.O. BOX)

\_\_\_\_\_  
(CITY / STATE / ZIP CODE)

PHONE: \_\_\_\_\_  
(AREA CODE)

EMAIL: \_\_\_\_\_

**(BOARD USE ONLY)**

APPROVED BY: \_\_\_\_\_ DATE: \_\_\_\_\_



**LIGHTING & POWER PLANS**

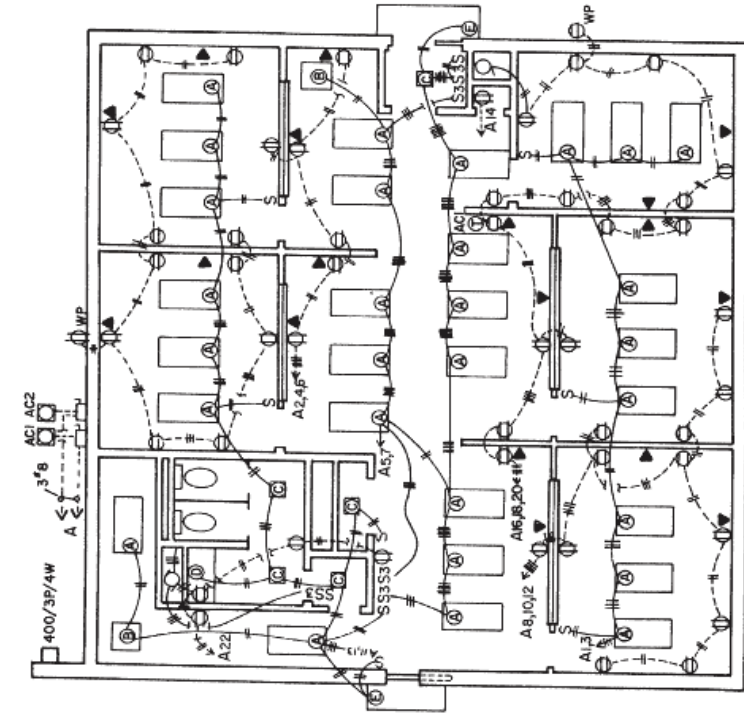

**FIRST FLOOR LIGHTING & POWER PLAN** SCALE 1/8" = 1'-0"

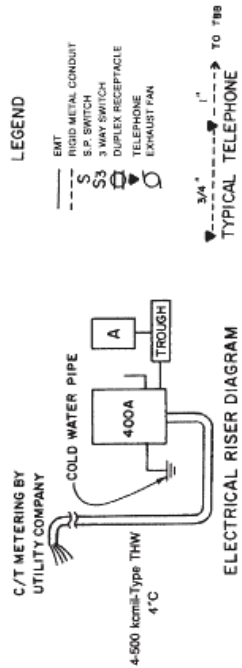

- NOTES**
1. RUNWAYS AND INSTALL. A SPOOL-RACK FOR SERVICE ATTACHMENT.
  2. MAIN SWITCH SHALL BE 400A, 3P, 3W, 240 V, FUSES, WITH 400A PANEL, F.B.O., INSTALLED BY ELECTRICAL.
  3. C.T. CABINET AND METER CAN, F.B.O., INSTALLED BY ELECTRICAL.
  4. PANEL SHALL BE: 1. 200A, 3P, 3W, 240V ACB, WITH 8 SPARE 200V C.B. 2. 2 ACTIVE 200V C.B. 3. TELEPHONE SERVICE IS TO BE 4\" RIGID STEEL WITH FULL WIRE FROM SERVICE POINT TO TBB. 4. DEVICES SHALL BE: 1. 3. HUBBELL # 1201 5. HUBBELL # 1203 5. HUBBELL # 1203 PHENOLIC PLATES SHALL BE BROWN.
  5. TANK SHALL BE COPPER.
  6. EXHAUST FANS (500 Watts each) and A.
  7. RUNWAYS AND INSTALL. A SPOOL-RACK FOR SERVICE ATTACHMENT.
  8. EXHAUST FANS (500 Watts each) and A.
  9. EQUIPMENT ARE BY OTHERS RUNWAYS AND INSTALL. A SPOOL-RACK FOR SERVICE ATTACHMENT ON EACH FLOOR TO ALL A.C. EQUIPMENT FOR THAT FLOOR.
  10. FURNISH ALL ITEMS REQUIRED FOR COMPLETE INSTALLATION FOR ELECTRICAL DRAWINGS. INSTALLATION SHALL BE IN PERFORMANCE WITH N.E.C.
  11. DEAD-END WIRE BID. IF ALL LIGHT FIXTURES WITH LAMPS ARE FURNISHED BY OWNER, INSTALLED BY E.C.

**CONSTRUCTION NOTES**

FLOOR HEIGHT 10'0"  
 CEILING HEIGHT 9'0"  
 CEILING IS 2" X 4" LAY-IN TILE  
 PARTITIONS ARE METAL STUDS AND 1/2" DRY WALL.

**COLOR CODE SPECIFICATION**

PHASE A: BLACK  
 PHASE B: RED  
 PHASE C: BLUE  
 NEUTRAL: WHITE

MARK	CAT. NO.	MOUNTING	LAMPS
A	LITHONIA 28240 A12	RECESSED	2-F40T12/RS/AV
B	LITHONIA 2F2400 A12	RECESSED	2-F40U/CW
C	ART METAL 1510P-SMS	SURFACE	1-150 IF
D	ART METAL 3549	SURFACE	2-75 IF
E	ART METAL 3570	SURFACE	1-150 IF
F	SAFELITE	SURFACE	1-151F
G	LITHONIA CP86	SURFACE	2-F40T12/CW/SL
H	LITHONIA S120TS	SURFACE	1-F20TS/CW
J	ART METAL R91	RECESSED	1-100 IF
K	KEYLESS	SURFACE	1-100 IF

MINIMUM FLEXIBLE METAL CONDUIT TO RECESSED FIXTURES 4"

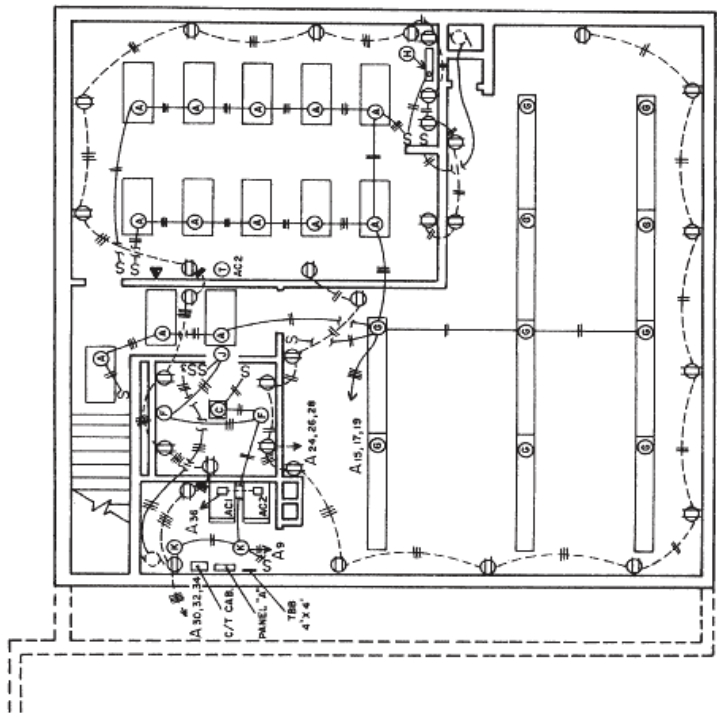

**BASEMENT LIGHTING AND POWER PLAN** SCALE 1/8" = 1'-0"

PANEL A	WIRE AND CONDUIT SIZE	MB	VOLTAGE	MOUNTING		LOAD SERVED
				FLUSH	SURFACE	
LIGHTS	20	20	120/208	3	4	RECEPTACLE
LIGHTS	20	20	120/208	3	4	RECEPTACLE
SPARE	20	20	120/208	3	4	RECEPTACLE
SPARE	20	20	120/208	3	4	RECEPTACLE
AC-1 SWITCH	20	20	120/208	3	4	AC-1 AND AC-2 PANELS
AC-2 SWITCH	20	20	120/208	3	4	AC-2 SWITCH

SO D TYPE NQOB  
 225 AMP MAIN BREAKER

**NC STATE BOARD OF EXAMINERS  
OF ELECTRICAL CONTRACTORS**  
505 N. GREENFIELD PARKWAY  
SUITE 100  
GARNER, NC 27529

**MEDIA MAIL**